



**OPERATION AND SERVICE MANUAL**

**MODEL 620L**  
Line Leakage Tester

**Fully Automated Line Leakage Tester**

**SERIAL NUMBER**

--	--	--	--	--	--	--

Model 620L  
Item 38837, Ver. 1.28  
February 2023



\*Select models only.  
See specs for details.

Associated Research  
28105 North Keith Dr. - Lake Forest, IL 60045 USA  
T. 1-847-367-4077 F. 1-847-367-4080  
[info@ikonix.com](mailto:info@ikonix.com) [www.arisafety.com](http://www.arisafety.com)

---

# DECLARATION OF CONFORMITY



**Manufacturer:** Associated Research, An Ikonix Brand  
**Address:** 28105 N. Keith Drive  
Lake Forest, IL 60045 USA  
**Product Name:** Line Leakage Tester  
**Model Number:** 620L

## Conforms to the following Standards:

**Safety:** IEC 61010-1:2010+A1:2019,  
IEC 61010-2-030:2010  
EN 61010-1: 2010/A1: 2019, BS EN 61010-1:2010+A1:2019  
EN 61010-2-030:2010 , BS EN 61010-2-030:2010  
EN 61010-031:2002+A1:2008, BS EN 61010-031:2002+A1:2008  
UL 61010-1:2012 R7.19, UL 61010-2-030:2012  
CAN/CSA-22.2 NO. 61010-1-12+GI1+GI2 (R2017)+A1  
CAN/CSA-22.2 NO. 61010-2-030-12

**EMC:** EN 61326-1:2013, BS EN 61326-1:2013  
EN 55011:2010/A1:2010/A2:2002 Class A,  
EN 61000-3-2:2006,  
EN 61000-3-3:1995/A1:2001/A2:2005,  
IEC 61000-4-2:1995/A2:2000,  
EN 61000-4-3:2002, IEC 61000-4-4:2004,  
IEC 61000-4-5:1995/A1:2000,  
IEC 61000-4-6:2003,  
IEC 61000-4-8:1993/A1:2000,  
IEC 61000-4-11:2004

## Supplementary Information

*The product herewith complies with the requirements of the **Low Voltage Directive 2014/35/EU**, **EMC Directive 2014/30/EU** and the **RoHS Directive 2015/863/EU** with respect to the following substances: Lead (Pb), Mercury (Hg), Cadmium (Cd), Hexavalent chromium (Cr (VI)), Polybrominated biphenyls (PBB), Polybrominated diphenyl ethers (PBDE), Bis phthalate (DEHP), Dibutyl phthalate (DBP), Benzyl butyl phthalate (BBP), Diisobutyl phthalate (DIBP), Deca-BDE included.*

**Last two digits of the year in which the CE marking was affixed: 08**

*The technical file and other documentation are on file with Associated Research, An Ikonix Brand*

Adam Braverman, President  
Associated Research  
Lake Forest, Illinois USA  
December 2022

# TABLE OF CONTENTS

<b>1. INTRODUCTION .....</b>	<b>1</b>
1.1. Warranty Policies .....	1
1.2. Safety Symbols.....	3
1.2.1. Product Marking Symbols.....	3
1.2.2. Caution and Warning Symbols .....	3
1.3. Glossary of Terms.....	3
1.4. Safety .....	5
1.4.1. Service and Maintenance .....	5
1.4.2. Test Station.....	7
1.4.3. Test Operator.....	9
1.5. Key Features of the 620L .....	10
<b>2. GETTING STARTED .....</b>	<b>12</b>
2.1. Unpacking and Inspection .....	12
2.1.1. Packaging.....	12
2.1.2. Contents of Carton.....	12
2.1.3. Returning the Instrument for Service or Calibration .....	13
2.2. Installation .....	13
2.2.1. Work Area .....	13
2.2.2. Power Requirements.....	13
2.2.3. Basic Connections .....	14
2.2.4. Environmental Conditions.....	15
<b>3. SPECIFICATIONS AND CONTROLS .....</b>	<b>16</b>
3.1. 620L Functional Specifications .....	16
3.2. Instrument Controls .....	22
3.2.1. Front Panel Controls.....	22
3.2.2. Rear Panel Controls .....	24
<b>4. PROGRAMMING INSTRUCTIONS.....</b>	<b>29</b>
4.1. Power Up.....	29
4.2. Setup System .....	29
4.2.1. Setup System Keys .....	30
4.2.2. Time and Date .....	30
4.2.3. Calibration Alert.....	31
4.2.4. Hardware.....	34
4.2.5. Security.....	36
4.2.6. Power-On Screen .....	38
4.2.7. Default System Parameters .....	40
4.3. Setup Tests Menu.....	40
4.3.1. Add .....	41
4.3.2. Edit .....	41
4.3.3. Delete.....	41
4.3.4. Prompt .....	41

4.3.5. File .....	43
4.3.6. Fail Stop .....	44
4.4. Test Parameters.....	45
4.4.1. Description of Test Parameters .....	45
4.4.2. Default Parameters.....	47
4.5. Setting Up a Test .....	49
4.5.1. General Test Procedures.....	49
4.5.2. Line Leakage Test .....	51
4.5.3. Scanner.....	58
4.5.4. Run Test.....	59
<b>5. OPERATING INSTRUCTIONS .....</b>	<b>61</b>
5.1. Instrument Connections .....	61
5.1.1. DUT-Input Voltage Connections .....	61
5.1.2. Connecting the Test Leads .....	62
5.1.3. DUT Output Connections.....	62
5.1.4. Adapter Box Connections .....	63
5.1.5. Interlock Connector.....	64
5.2. Perform Tests Menu .....	64
5.2.1. Load File.....	65
5.2.2. Single Step.....	65
5.2.3. Fail Stop .....	66
5.2.4. Results.....	66
5.3. Performing a Test.....	68
5.4. Perform Tests Metering.....	69
5.5. Displayed Messages .....	70
5.5.1. Test Status Messages.....	70
5.5.2. Error Messages .....	70
<b>6. CONNECTION OF REMOTE I/O .....</b>	<b>74</b>
6.1. Remote Signal Outputs .....	74
6.2. Remote Signal Inputs and Memory Access.....	75
6.3. Remote Interlock.....	77
<b>7. BUS REMOTE INTERFACE GPIB / RS-232.....</b>	<b>79</b>
7.1. RS-232 Interface .....	79
7.1.1. RS-232 Connector .....	79
7.1.2. Communications Port Configuration .....	80
7.1.3. Sending and Receiving Commands.....	81
7.2. GPIB Interface .....	81
7.2.1. GPIB Connector .....	81
7.2.2. GPIB Address.....	82
7.3. Interface Functions .....	82
7.4. RS-232 / GPIB Interface Command List .....	82
7.4.1. Echo and Response Considerations .....	82

7.4.2. Test Execution Commands .....	83
7.4.3. File Editing Commands .....	83
7.4.4. Test Parameter Editing Commands and Companion Queries ....	89
7.4.5. System Parameter Editing Commands and Companion Queries	90
7.4.6. Query Commands .....	91
7.4.7. IEEE 488.2 Common Commands .....	94
7.4.8. Status Reporting .....	96
7.4.9. GPIB Service Request .....	97
7.5. Non-Volatile Memory .....	98
<b>8. OPTIONS .....</b>	<b>101</b>
8.1.1. GPIB Interface .....	101
8.1.2. HV/HC Interconnect.....	101
8.1.3. Remote Memory Send .....	106
<b>9. CALIBRATION PROCEDURE.....</b>	<b>147</b>
9.1. Warranty Requirements .....	147
9.2. Calibration Initialization .....	148
9.3. Required Measurement Equipment .....	148
9.4. Verify the High Frequency Noise.....	148
9.4.1. Calibration of Run Test Voltage.....	149
9.4.2. Calibration of Run Test Current.....	150
9.4.3. Calibration of Run Test Current.....	151
9.4.4. Calibration of Run Test Power .....	152
9.4.5. Calibration of Run Test Power.....	153
9.4.6. Calibration of Run Test Leakage.....	154
9.4.7. Calibration of LLT MD V Offset.....	155
9.4.8. Calibration of LLT MD Volts x 0.1.....	156
9.4.9. Calibration of LLT MD Volts x 1 .....	157
9.4.10. Calibration of LLT MD Volts x 4 .....	158
9.4.11. Calibration of LLT MD Volts x 16.....	159
9.4.12. Calibration of LLT MD Volts x 64.....	160
9.4.13. Calibration of LLT MD Volts x 256 .....	161
9.4.14. Calibration of LLT MD Volts x 0.1.....	162
9.4.15. Calibration of LLT MD Volts x 0.1.....	163
9.4.16. Calibration of LLT MD Volts x 1 .....	164
9.4.17. Calibration of LLT MD Volts x 1 .....	165
9.4.18. Calibration of LLT MD Volts x 4 .....	166
9.4.19. Calibration of LLT MD Volts x 4 .....	167
9.4.20. Calibration of LLT MD Volts x 16.....	168
9.4.21. Calibration of LLT MD Volts x 16.....	169
9.4.22. Calibration of LLT MD Volts x 64.....	170
9.4.23. Calibration of LLT MD Volts x 64.....	171
9.4.24. Calibration of LLT MD Volts x 256 .....	172
9.4.25. Calibration of LLT MD Volts x 256 .....	173
9.4.26. Calibration of LLT MD: UL544NP measuring device .....	174
9.4.27. Calibration of LLT MD: UL 544P measuring device .....	175

9.4.28. Calibration of LLT MD: ICE601-1 measuring device.....	176
9.4.29. Calibration of LLT MD: UL1563 measuring device.....	177
9.4.30. Calibration of LLT MD: IEC 1010 measuring device .....	178
9.4.31. Calibration of LLT MD: IEC60990 FIG4 measuring device .....	179
9.4.32. Calibration of LLT MD: IEC 60990 FIG5 measuring device.....	180
<b>10. REPLACEMENT PARTS LIST .....</b>	<b>181</b>
<b>11. SCHEMATIC INDEX.....</b>	<b>183</b>
<b>12. INDEX.....</b>	<b>217</b>

---

## 1. INTRODUCTION

### 1.1. Warranty Policies

Ikonix Brand, certifies that the tester listed in this manual meets or exceeds published manufacturing specifications. This tester was calibrated using standards that are traceable to the National Institute of Standards and Technology (NIST).

Your new tester is warranted to be free from defects in workmanship and material for a period of (5) years from date of shipment. We aim to provide an amazing experience and quality testers that last a long time. If you're not satisfied with your tester, return it within 45 days for a full refund. Calibrate annually with us, or one of our authorized partners, and we'll extend your warranty an additional year for the service life of your tester, and at least five years after discontinuation. If it breaks during that time, we promise to fix it for free (unless abuse or excessive damage is present). When your tester reaches the end of its service life, we'll responsibly recycle it and give you a discount on a replacement. Annual calibration and inspection must be made in each successive year starting one year after the original purchase date in order to remain eligible for extended warranty coverage beyond the standard warranty period (five years).

Ikonix Brand recommends that your tester be calibrated on a twelve-month cycle. A return material authorization (RMA) must be obtained from Ikonix Brand. To obtain an RMA please contact our Customer Support team at 1-847-367-4077 or visit <https://www.ikonixusa.com/support/rma-request>. Damages sustained as a result of improper packaging will not be honored. Transportation costs for the return of the tester for warranty service must be prepaid by the customer. Ikonix Brand will assume the return freight costs when returning the tester to the customer. The return method will be at the discretion of Ikonix Brand.

Except as provided, herein Ikonix Brand makes no warranties to the purchaser of this tester and all other warranties, expressed or implied (including, without limitation, merchantability or fitness for a particular purpose), are hereby excluded, disclaimed and waived.

Any non-authorized modifications, tampering or physical damage will void your warranty. Elimination of any connections in the earth grounding system or bypassing any safety systems will void this warranty. This warranty does not cover accessories not of Ikonix Brand manufacture. Parts used must be parts that are recommended by Ikonix Brand as an acceptable specified part. Use of non-authorized parts in the repair of this tester will void the warranty.

\*5 year warranty is valid on any model purchased in 2021 or after.

**\*\*This Page Intentionally Left Blank\*\***



## 1.2. Safety Symbols

### 1.2.1. Product Marking Symbols



Product will be marked with this symbol when it is necessary to refer to the operation and service manual in order to prevent injury or equipment damage.



Product will be marked with this symbol when hazardous voltages may be present.



Product will be marked with this symbol at connections that require earth grounding.

### 1.2.2. Caution and Warning Symbols



Calls attention to a procedure, practice, or condition that could possibly cause bodily injury or death.



Calls attention to a procedure, practice, or condition that could possibly cause damage to equipment or permanent loss of data.

## 1.3. Glossary of Terms

(As used in this manual)

**Alternating Current, AC:** Current that reverses direction on a regular basis. Utility power is usually generated in the form of a sinusoid at a frequency of 60 times per second in the United States and 50 times per second in other countries.

**Arc:** A partial momentary breakdown due to the force of a strong electric field on closely spaced conductors, sometimes evidenced by corona or a luminous flashover.

**Breakdown:** The failure of insulation to effectively prevent the flow of current. If the test voltage is gradually raised, breakdown will begin suddenly at a certain voltage level and current flow will not be directly proportional to voltage. Once a breakdown occurs, especially for a period of time, the next gradual application of voltage will often cause a breakdown to begin at a lower voltage.

**Conductor:** A solid or liquid material which permits the flow of electrons. A material which has a volume resistivity of no more than  $10^3 \Omega\text{-cm}$ .

**Current:** The movement of electrons through a conductor. Current is measured in amperes (A), milliamperes (mA), microamperes ( $\mu\text{A}$ ). Symbol = I

**Dielectric:** An insulating material that is positioned between two conductive materials in such a way that a charge or voltage may appear across the two conductive materials.

**Direct Current, DC:** Current that flows in one direction only. The source of direct current is said to be polarized and has one terminal that is always at a higher potential than the other.

**Frequency:** The number of cycles an AC waveform repeats over time. Usually given in Hertz (Hz).

**Ground:** Refers to the point of low potential in a circuit to which all other voltages are referenced. May or may not be tied to the earth. Also referred to as Earth.

**Hot:** Used to refer to the test lead or output side of an instrument that is at high potential.

**Impedance:** The property of capacitive or inductive items to limit certain frequencies.

**Insulation:** Gas, liquid or solid material which has a volume resistivity of at least  $10^{12}$   $\Omega$ -cm and is used for the purpose of restricting current flow between conductors.

**Leakage:** AC or DC current flow through insulation and over its surfaces. Current flow is directly proportional to voltage. The insulation is thought of as a constant impedance unless breakdown occurs.

**Neutral:** The point of low potential in a circuit to which all other voltages are referenced. Also known as Common.

**Peak Current:** The maximum amplitude of an AC current waveform. For a sinusoid, 1.414 x the RMS value.

**Power:** The amount of work performed by an energy source over time, given in Watts (W).

**PF (Power factor):** Power Factor =  $W/VA$  where  $W$  =Watts (Real Power) and  $VA$  =Volts x Amps (apparent power). It is important to note that the closer the power factor is to "1" the more resistive the DUT is. The closer the power factor is to 0 the more reactive (inductive or capacitive) the DUT is.

**Reactive Current:** The current component due to the reactive impedance of a load. Also called imaginary current.

**Real Current:** The current component due to the resistance of a load.

**Resistance:** The property of a substance that impedes current and results in the dissipation of power in the form of heat. The practical unit of resistance is the *ohm* ( $\Omega$ ). Symbol = **R**

**Return:** The path by which current returns to a source.

**RMS:** The Root Mean Squared value of a voltage or current waveform. An RMS waveform delivers the same amount of energy to a load as a DC waveform of the same value. For a sinusoid, the RMS value is .707 x the peak value.

**Total Current:** The vector sum of the real current component and the reactive current component produced by an applied voltage.

**VA:** A rating of instantaneous power found by multiplying an instrument's maximum output current by its maximum output voltage.

**Voltage:** The force which causes current through an electrical conductor, given in volts (V).  
Symbol = V

## 1.4. Safety

This product and its related documentation must be reviewed for familiarization with safety markings and instructions before operation.

This product is a Safety Class I instrument (provided with a protective earth terminal). Before applying power verify that the instrument is set to the correct line voltage (115 or 230) and the correct fuse is installed.

This product carries an NRTL (Nationally Recognized Testing Laboratory) and comes equipped with an audible and visual failure indicator.

### WARNING

The 620L produces voltages and currents that can cause **harmful or fatal electric shock**. To prevent accidental injury or death, these safety procedures must be strictly observed when handling and using the test instrument.

### 1.4.1. Service and Maintenance

#### User Service

To prevent electric shock do not remove the instrument cover. There are no internal user serviceable parts. Routine maintenance or cleaning of internal parts is not necessary. Avoid the use of cleaning agents or chemicals on the instrument, as some chemicals may damage plastic parts or lettering. Any external cleaning should be done with a clean, dry or slightly damp cloth. Schematics, when provided, are for reference only. Refer servicing and certification to an Associated Research authorized service center.

### SAFETY

This instrument meets UL requirements for audible and visual failure indication.

ASSOCIATED RESEARCH an Ikonix  
Brand  
28105 N. Keith Drive  
LAKE FOREST, IL 60045-4546 U.S.A.

PHONE: 1 (847) 367-4077  
**1 (800) 858-TEST (8378)**  
FAX: 1 (847) 367-4080  
E-MAIL: [info@ikonix.com](mailto:info@ikonix.com)

### **Service Interval**

Associated Research will not be held liable for injuries suffered if the instrument is not properly maintained and safety checked annually. See section **1.1. Warranty Policies** for more information.

## 1.4.2. Test Station

### Location

Select an area away from the mainstream of activity where employees do not walk while performing their normal duties. If this is not practical because of production line flow, then the area should be roped off and marked for **HIGH VOLTAGE TESTING**. No employees other than test operators should be allowed inside.

If benches are placed back-to-back, be especially careful about the use of the bench opposite the test station. Signs should be posted: **“DANGER – HIGH VOLTAGE TEST IN PROGRESS – UNAUTHORIZED PERSONNEL KEEP AWAY.”**

### Work Area

When possible, use the instrument on a non-conducting table or workbench. If you cannot avoid using a conductive surface, be certain that it is connected to a good earth ground and the high voltage connection is insulated from the grounded surface.

There should not be any metal in the work area between the operator and the location where products being tested will be positioned. Any other metal in the work area should be connected to a good ground, never left “floating”.

Keep the area clean and uncluttered. All test equipment and unnecessary test leads should be removed from the test bench and put away. It should be apparent to both the operator and to any observers which product is under test, which product is waiting to be tested and which product has already been tested.

### Power

Power to the test station should be arranged so that it can be shut off by one prominently marked switch located at the entrance to the test area. In case of an emergency, anyone should be able to cut off the power before entering the test area to offer assistance.

### ESD TESTING

Electrical safety tests should not be performed in or around ESD testing areas. ESD methods should not be employed during electrical safety testing, as this could cause a hazardous condition for equipment and test operators.

### More Information

For more information on setting up a safe work station, please visit the Events and Training section of our website at <https://www.ikonixusa.com/education/whitepapers>



### 1.4.3. Test Operator

#### **WARNING**

This instrument generates voltages and currents that can cause **harmful or fatal electric shock** and must only be operated by a skilled worker trained in its use. **The operator should understand the electrical fundamentals of voltage, current, and resistance.**

#### **WARNING**

**Do not touch the device under test, high voltage test lead, alligator clip, or clip insulator once the test has been started.**

#### **WARNING**

**Do not touch the front panel when testing or after a malfunction has occurred.**

#### **Rules**

Operators should be thoroughly trained to follow all national safety standard guidelines for electrical safety testing in the workplace. Defeating any safety system should be considered a serious offense with severe penalties. Allowing unauthorized personnel in the area during a test should also be dealt with as a serious offense. Test operators should be familiar with methods to properly discharge a device under test in case test leads become disconnected during testing.

Refer to the following standards for more information:

- NFPA 70E
- OSHA 1910 subpart (S)
- EN50191

#### **Dress**

Operators should not wear jewelry that could accidentally complete a circuit.

#### **WARNING**

ESD protocols should not be observed while performing electrical safety tests. Intentionally grounding the test operator could lead to a **harmful or fatal electric shock**.

#### **Medical Restrictions**

Personnel with heart ailments or devices such as pacemakers should be informed that the voltages and currents generated by the instrument are very dangerous. If contacted, the instrument may cause heart-related problems. Please have the test operator consult a physician for recommendations.

#### **KEY SAFETY POINTS TO REMEMBER**

- Keep unqualified and unauthorized personnel away from the test area.
- Arrange the test station in a safe and orderly manner.
- In case of any problem, turn off the high voltage first.

## 1.5. Key Features of the 620L

<b>ENHANCED GRAPHIC LCD DISPLAY</b>	Provides the operator with the ability to complete test setups and review results in an easy-to-use interface. Eliminates the need to decipher cryptic abbreviations. The graphic display makes testing safer, easier and more reliable than ever before.
<b>CAL-ALERT</b>	Alerts the operator that the machine is due for calibration in advance of the calibration due date.
<b>SECURITY ACCESS</b>	This allows the instrument to be setup to allow for different levels of access to the instruments setup programs. Users can setup passwords for restricting access to certain parts of the menu.
<b>50 PROGRAMMABLE TEST SETUPS WITH 30 STEPS PER SETUP</b>	Each test setup can store up to 30 steps which can be configured to perform any of the safety tests. All steps can be linked together to form a complete automated test routine. Each setup can be named for easy identification and recall.
<b>EXCLUSIVE PROMPT AND HOLD FUNCTION</b>	The 620L allows operators to setup a user-configured message that is displayed in between test steps. This is a very convenient feature for applications where test leads need to be moved or when DUT switches need to be activated as part of the test cycle.
<b>PLC REMOTE INPUTS &amp; OUTPUTS</b>	Two standard 9 pin interfaces provide outputs for PASS, FAIL, RESET and TEST IN PROCESS signals. Inputs include TEST, INTERLOCK, RESET and remote recall of MEMORIES 1 - 10. Provides the user with the ability to operate the 620L through simple PLC relay control.
<b>6 BUILT-IN MEASURING DEVICES WITH EXTERNAL CONNECTION CAPABILITY</b>	The 620L has 6 built-in measuring devices as specified by the most common industry standards. In addition, operators may connect a custom measuring device of their own to the external measuring device inputs.
<b>INTERCONNECTION CAPABILITY WITH HIPOT AND GROUND BOND TESTERS</b>	The 620L may be connected to a Hypot III, Hyamp III, HypotULTRA III, or HypotMAX safety tester to form a complete electrical safety testing system.



<b>INTERCONNECTION CAPABILITY WITH MODULAR SCANNER</b>	The 620L can be connected to an Associated Research, Inc. SC6540 Modular Scanner for multi-point testing capability.
<b>RMS AND PEAK LEAKAGE CURRENT READINGS</b>	Select to monitor leakage current using RMS or Peak readings during Line Leakage testing.
<b>40 AMP CONTINUOUS CURRENT CAPABILITY</b>	The 620L can handle loads that require up to 40 Amps of continuous current during Line Leakage and Run testing.
<b>CONTINUOUS POWER OUTPUT SELECTION</b>	Power runs continuously between test steps for more efficient testing.
<b>INTERCONNECTION CAPABILITY WITH ASSOCIATED POWER TECHNOLOGIES AC POWER SOURCE</b>	The 620L may be connected with an Associated Power Technologies power source for clean DUT power. Up to 7 pre-set memories may be selected from the 620L menu system DUT's that require multiple input waveforms.
<b>BUILT IN GFI CIRCUIT</b>	The 620L contains a built-in GFI circuit that monitors DUT input power. This feature safeguards the operator if excessive current flowing to ground is detected.

## 2. GETTING

### Introduction

This section contains information for the unpacking, inspection, preparation and storage of your Associated Research, Inc., product.

### 2.1. Unpacking and Inspection

#### 2.1.1. Packaging

Your instrument was shipped in a custom foam insulated container. If the shipping carton is damaged, inspect the contents for visible damage such as dents, scratches or a broken display. If the instrument is damaged, notify the carrier and Associated Research, Inc.'s customer support department. **Please save the shipping carton and packing material for the carrier's inspection.** Our customer support department will assist you in the repair or replacement of your instrument. Please do not return your product without first notifying us and receiving an RMA (return material authorization) number. To receive an RMA number, please contact our customer support department at 1-800-858-TEST (8378).

#### 2.1.2. Contents of the Carton

Inside the carton should be the following:

Description	AR Part Number
The Instrument	00620L
Probe Cable (Qty 2)	02100A-13
High Current Input LINE Cable	38841
High Current Input NEUTRAL Cable	38842
High Current Output LINE Cable	38833
High Current Output NEUTRAL Cable	38834
High Current GND Cable Red	CBLHC40-10TLR
Fuse 2A 250V Slow Blow 20mm	37923
USB Cable AB-Type 1.8m	39066
Line Cord Standard *	33189
Adapter Box *	38777
Interlock Connector	38705
Bracket Rack Mount 3U (Qty 2)	38788
Handle Rack Mount 3U (Qty 2)	38787
Screw M4 x 12mm FHMS (Qty 4) for Rack Mount Handle	38549

### **WARNING**

Only accessories which meet the manufacturer's specification shall be used.

- **Note:** The Adapter Box (universal US polarity) and line cord listed are American. Other combinations of line cord and Adapter Box are available upon request.

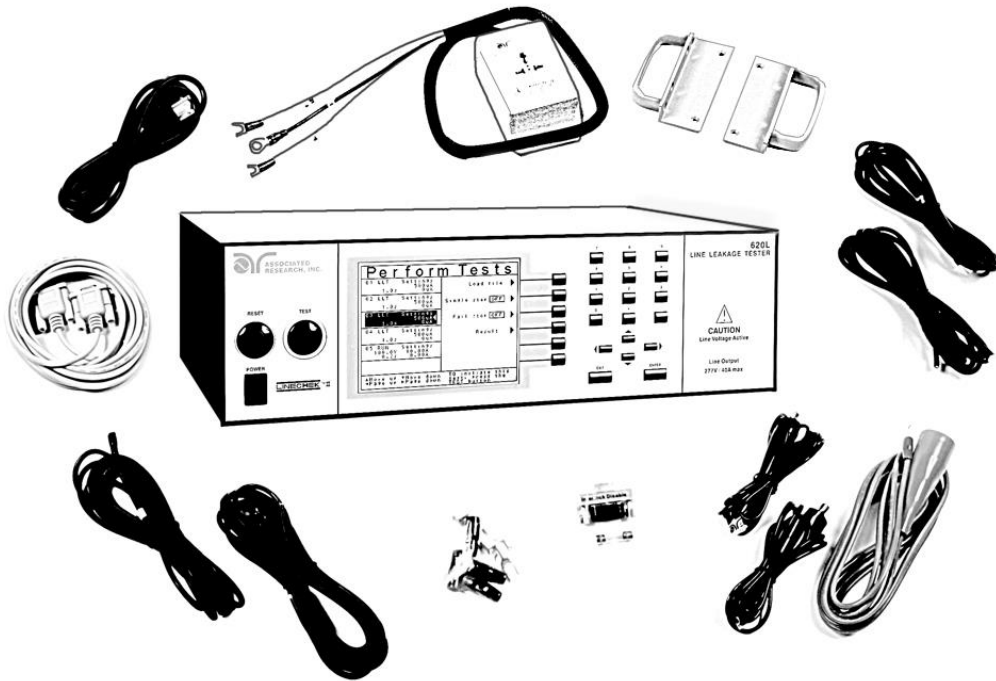

## 2.2. Installation

### 2.2.1. Work Area

#### **WARNING**

Locate a suitable testing area and be sure you have read all safety instructions for the operation of the instrument and suggestions on the test area setup in section **1.4. Safety**.

Make sure the work area you choose has a three-prong grounded outlet capable of supplying the necessary input current to the power source. Be sure the outlet has been tested for proper wiring before connecting the instrument to it.

#### **WARNING**

The mains plug is used as the disconnecting device and shall remain readily operable. The socket-outlet shall be installed near the equipment and shall be easily accessible.

### 2.2.2. Power Requirements

This instrument requires a power source of either 115 volts AC  $\pm 10\%$ , 50/60 Hz single phase or 230 volts AC  $\pm 10\%$ , 50/60 Hz single phase. Before applying power verify that the instrument is set to the correct line voltage (115 or 230 volts). Adjust the voltage select switch to 115 for use with a 115 volt input. Adjust the voltage select

switch to 230 for use with a 230 volt input. See section **3.2.2. Rear Panel Controls** for an image of the rear panel.

**CAUTION**

Do not replace the power supply cord with an improperly rated cord. For North American: A UL listed and CSA labeled power cord must be used with the instrument in the United States and Canada. The power cord must include a NEMA5-15 style male plug, SVT or SJT cord sets, and be rated for at least 125VAC, 10A, number 16 gauge (or 125VAC, 15A, number 14 gauge) wire or larger, and the length of the cord does not exceed 2 m must be used. For European: A certified power supply cord not lighter than light PVC sheathed flexible cord according to IEC 60227, designation H03 VV-F or H03 VVH2-F (for equipment mass not exceeding 3 kg), or H05 VV-F or H05 VVH2-F2 (for equipment mass exceeding 3 kg), and be rated for at least 3G 0.75 mm<sup>2</sup> (for rated current up to 10 A) or 3G 1.0mm<sup>2</sup> (for rated current over 10 A up to 16 A) wire or larger, and the length of the cord does not exceed 2 m must be used.

**CAUTION**

Do not switch the line voltage selector switch located on the rear panel while the instrument is on or operating. This may cause internal damage and represents a safety risk to the operator.

**WARNING**

The 620L must be connected to a good ground. Be certain that the power wiring is properly polarized and that the proper low resistance bonding to ground is in place.

### 2.2.3. Basic Connections

#### Power Cable

The instrument is shipped with a line cord containing a protective earth ground. When the line cord is connected to an appropriate AC power source the cable will connect the chassis to earth ground.

**WARNING**

The main plug shall only be inserted in a socket outlet with a protective ground (earth) contact. This protective ground **must not be defeated** by the use of an extension cord without a protective conductor.

#### Return Connection

When the instrument's return is grounded, any internal and external stray leakage will be monitored due to currents that flow from high voltage to earth ground (such as from high voltage to the chassis of the instrument). These currents are inherent and will cause errors when trying to monitor very low leakage currents in the microamp range.

The output power supplies of this instrument are referenced directly to earth ground. Any conductor that completes a path between the high voltage and earth ground will form a completed circuit.

#### **2.2.4. Environmental Conditions**

This equipment is intended for indoor use only. The equipment has been evaluated according to Installation Category II and Pollution Degree 2 as specified in IEC 664.

This instrument may be operated in environments with the following limits:

Temperature..... 41° - 104° F (5° - 40°C)  
Relative humidity..... 0 – 80%  
Altitude..... 6560 feet (2,000 meters)



Keep the ventilation slits uncovered during operation. Failure to do so could cause the instrument to overheat and may damage internal components.

#### **Storage and Shipping Environment**

This instrument may be stored or shipped in environments with the following limits:

Temperature..... -40° - 167° F (-40° - 75°C)  
Altitude..... 50,000 feet (15,240 meters)

The instrument should also be protected against temperature extremes that may cause condensation within the instrument.



Failure to operate this instrument within the specified conditions could result in damage.

If the instrument is used in a manner not specified by the manufacturer, the protection provided by the instrument may be impaired.

#### **More Information**

For more information on test operator and workstation safety please visit the Events and Training section of our website <https://www.ikonixusa.com/education/whitepapers>

## 3. SPECIFICATIONS AND

### 3.1. 620L Functional Specifications

<b>INPUT</b>		
Voltage	115/230 VAC $\pm$ 10%, User selection	
Frequency	50/60 Hz $\pm$ 5%	
Fuse	2A Slow-Blow 250V AC	
<b>LINE CONDITION</b>		
Reverse Power Switch	Reverse polarity switch setting select ON/OFF/AUTO ON: Reverse power OFF: Normal AUTO: Automatic Reverse Polarity. With AUTO mode, the polarity switches for normal conditions in one step setting menu but will run two steps for both conditions. In this mode, the unit only records and displays the maximum leakage current value.	
Neutral Switch	ON/OFF selection for single fault condition	
Ground Switch	ON/OFF selection for Class I single fault condition	
<b>PROBE SETTING</b>		
Surface to Surface (PH – PL)		
Surface to Line (PH – L)		
Ground to Line (G – L)		
<b>LEAKAGE LIMIT SETTING</b>		
Touch Current High Limit (RMS)	Range:	0.0uA ~ 999.9uA 1000uA ~ 9999uA 10.00mA ~ 20.00mA
	Resolution:	0.1uA / 1uA / 0.01mA
Touch Current Low Limit (RMS)	Range:	0.0uA ~ 999.9uA 1000uA ~ 9999uA 10.00mA ~ 20.00mA
	Resolution:	0.1uA/1uA/0.01mA
Touch Current High Limit (Peak)	Range:	0.0uA - 999.9uA 1000uA - 9999uA 10.00mA - 30.00mA
	Resolution:	0.1uA/1uA/0.01mA
Touch Current Low Limit (Peak)	Range:	0.0uA - 999.9uA 1000uA - 9999uA 10.00mA - 30.00mA
	Resolution:	0.1uA/1uA/0.01mA

DISPLAY		
Touch Current Display (RMS)	Range 1	0.0uA ~ 32.0uA, frequency DC, 15Hz - 1MHz
	Resolution	0.1uA
	Accuracy	DC , 15Hz ≤ f <100KHz: ±(2% of reading + 3counts) 100KHz ≤ f ≤ 1MHZ : ±5% of reading (10.0uA - 999.9uA)
	Range 2	28.0uA ~ 130.0uA, frequency DC, 15Hz - 1MHz
	Resolution	0.1uA
	Accuracy	DC , 15Hz ≤ f <100KHz: ±(2% of reading + 3counts) 100KHz ≤ f ≤ 1MHZ : ±5% of reading (10.0uA - 999.9uA)
	Range 3	120.0uA ~ 550.0uA, frequency DC, 15Hz - 1MHz
	Resolution	0.1uA
	Accuracy	DC , 15Hz ≤ f <100KHz: ±(2% of reading + 3counts) 100KHz ≤ f ≤ 1MHZ : ±5% of reading (10.0uA - 999.9uA)
	Range 4	400uA ~ 2100uA, frequency DC, 15Hz - 1MHz
	Resolution	1uA
	Accuracy	DC , 15Hz ≤ f <100KHz: ±(2% of reading + 3counts) 100KHz ≤ f ≤ 1MHZ : ±5% of reading (10uA - 8500uA)
	Range 5	1800uA ~ 8500uA, frequency DC, 15Hz - 1MHz
	Resolution	1uA
	Accuracy	DC , 15Hz ≤ f <100KHz: ±(2% of reading + 3counts) 100KHz ≤ f ≤ 1MHZ : ±5% of reading (10uA - 8500uA)
	Range 6	8.00mA ~ 20.00mA, frequency DC, 15Hz – 100kHz

DISPLAY (CONT.)		
	Resolution	0.01mA
	Accuracy	DC, $15\text{Hz} \leq f \leq 100\text{KHz}$ : $\pm 5\%$ of reading (0.01mA -20.00mA )
Touch Current Display (Peak)	Range 1	0.0uA ~ 32.0uA, frequency DC - 1MHz
	Resolution	0.1uA
	Accuracy	DC : $\pm(2\%$ of reading + 2uA) $15\text{Hz} \leq f \leq 1\text{MHz}$ : $\pm 10\%$ of reading + 2uA
	Range 2	28.0uA ~ 130.0uA, frequency DC - 1MHz
	Resolution	0.1uA
	Accuracy	DC : $\pm(2\%$ of reading + 2uA) $15\text{Hz} \leq f \leq 1\text{MHz}$ : $\pm 10\%$ of reading + 2uA
	Range 3	120.0uA ~ 550.0uA, frequency DC - 1MHz
	Resolution	0.1uA
	Accuracy	DC : $\pm(2\%$ of reading + 2uA) $15\text{Hz} \leq f \leq 1\text{MHz}$ : $\pm 10\%$ of reading + 2uA
	Range 4	400uA ~ 2100uA, frequency DC - 1MHz
	Resolution	1uA
	Accuracy	DC : $\pm(2\%$ of reading + 2uA) $15\text{Hz} \leq f \leq 1\text{MHz}$ : $\pm 10\%$ of reading + 2uA
	Range 5	1800A ~ 8500uA, frequency DC - 1MHz
	Resolution	1uA
	Accuracy	DC : $\pm(2\%$ of reading + 2uA) $15\text{Hz} \leq f \leq 1\text{MHz}$ : $\pm 10\%$ of reading + 2uA
	Range 6	8.0mA ~30.0mA, frequency DC – 100KHz
	Resolution	0.01mA
	Accuracy	DC : $\pm(2\%$ of reading + 3counts) $15\text{Hz} \leq f \leq 100\text{KHz}$ : $\pm 10\%$ of reading + 2counts



<b>MD CIRCUIT MODULE</b>		
MD1	UL544NP, UL484 , UL923, UL471, UL867, UL697	
MD2	UL544P	
MD3	IEC 60601-1	
MD4	UL1563	
MD5	IEC60990 Fig4 U2, IEC 62368-1, IEC60335-1, IEC60598-1, IEC60065, IEC61010	
MD6	IEC60990 Fig5 U3, IEC60598-1	
MD7	IEC62368, IEC61010-1 FigA.2 (2K ohm) for Run function.	
External MD	Basic measuring element 1k ohm	
Scope Output Interface	BNC type connector on rear panel for Oscilloscope connection	
MD voltage limit	Maximum 70VDC	
MD Component Accuracy	Capacitors = 5% Resistors = 1%	
<b>DUT POWER</b>		
AC Voltage	0.0 - 277.0V	
AC Current	40A max continuous	
AC Voltage High/Low Limit	Range:	0.0 - 277.0V
	Resolution:	0.1V / step
AC Voltage Display	Range:	0.0 - 277.0 V
	Resolution:	0.1 volt / step
	Accuracy:	± (1.5% of reading + 2 counts) , 30.0 - 277.0VAC
Delay time setting	Range:	0.5 – 999.9 seconds (AC+DC)/ 1.8-999.9sec (AC Only and DC Only AUTO Range)/ 1.3-999.9sec (AC Only and DC Only Fixed Range)
	Resolution:	0.1 second
Dwell Timer Setting	Range:	0, 0.5-999.9sec (AC+DC)/ 0.1-999.9sec (AC Only DC Only) (0=continuous)
	Resolution:	0.1
Timer display	Range:	0.0 – 999.9 seconds
	Resolution:	0.1 second
	Accuracy:	± (0.1% of reading + 0.05 seconds)
Failure Protection (start-up)	Neutral Voltage check (Neutral-V) Over current and ground current check (Line-OC)	

<b>GENERAL</b>		
Safety Agency Listing	CE, cTUVus, RoHS2	
PLC Remote Control	Input - Test, Reset, Interlock, and Recall Memory 1 through 10 (4Bits)	
	Output – Pass, Fail, Test-in-Process, Start-Out, Reset-Out	
Memory	50 files, 30step/file. File locations can be linked. 900 connected steps maximum.	
Display	320 X 240 graphic LCD	
LCD Contrast Setting	Adjustable	
Alarm Volume Setting	Adjustable	
Security	Lockout capability to avoid unauthorized access to test set-up programs. Security Password.	
Interface	USB/RS-232 standard	
Dimension	430 (W) x 133(H) x 300 (D) mm	
Weight	12 Kg	
GFI on DUT input power	Trip current = 5mA ± 10%	
<b>POWER METER</b>		
W	Range: 0-1KW / 1-10KW Resolution: 0.1W/1W,	
A	0.0 – 3.500 A / 3.00 - 40.00A Resolution: 0.001A / 0.01A	
PF	0.000 -1.000	
LA	Range:	0.0 -10.00 mA
	Resolution:	0.01mA
	Accuracy :	± (2 % of reading + 2 counts)
AC Current High/Low Limit Setting	Range:	0-40A
	Resolution:	0.01A/step
AC Current Display	Range 1:	0.000 – 3.500 A
	Resolution:	0.001A
	Accuracy :	± (2 % of reading + 5 counts)
AC Current Display	Range 2:	3.00 - 40.00A
	Resolution:	0.01A
	Accuracy :	± (2 % of reading + 2 counts)
AC Power High/Low Limit Setting	Range:	0 - 10KW
	Resolution:	1W
AC Power Display	Range:	0-1000W / 1000 - 10000W

GENERAL		
	Resolution:	0.1W / 1W
	Accuracy :	± (5 % of reading + 15 counts) V > 60V & PF > 0.1
Power Factor High/Low Limit Setting	Range:	0.000 - 1.000
	Resolution:	0.001
Power Factor Display	Range:	0.000 - 1.000
	Resolution:	0.001
	Accuracy :	W / VA, Calculated and displayed to three significant digits
Delay Timer Setting	Range:	0.5-999.9 seconds
	Resolution:	0.1
Dwell Timer Setting	Range:	0, 0.1-999.9 (0=continuous)
	Resolution:	0.1
Timer display	Range:	0.0 – 999.9 seconds
	Resolution:	0.1 second
	Accuracy:	± (0.1% of reading + 0.05 seconds)

### Why use the term “Counts”?

Associated Research publishes some specifications using COUNTS which allows us to provide a better indication of the tester’s capabilities across measurement ranges. A COUNT refers to the lowest resolution of the display for a given measurement range. For example, if the resolution for voltage is 1V then 2 counts = 2V.

## 3.2. Instrument Controls

### 3.2.1. Front Panel Controls

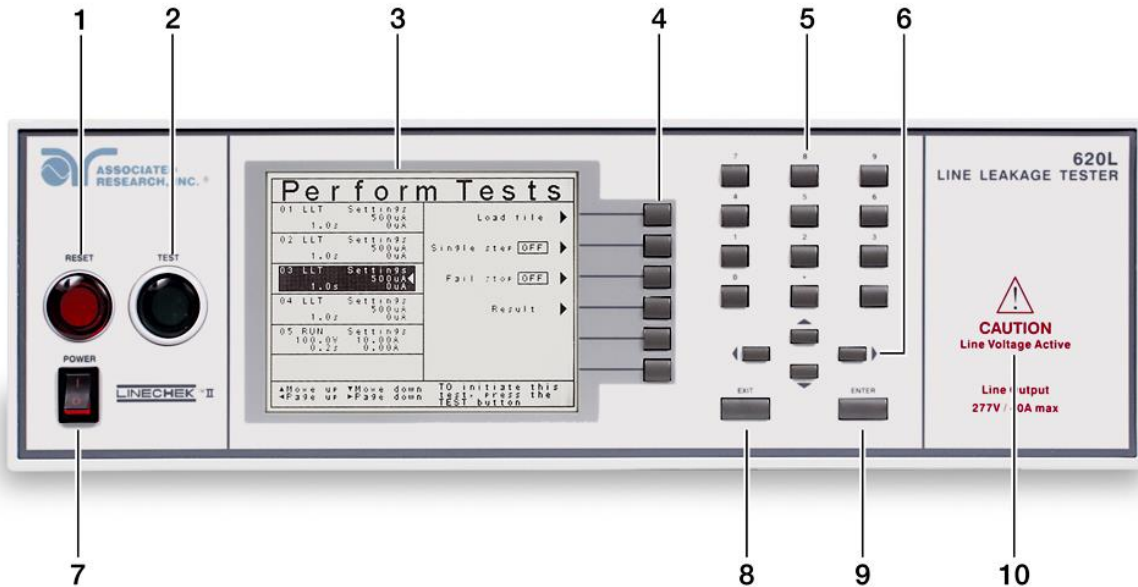

1. **RESET BUTTON:** Resets the instrument. If a failure condition occurs during a test, pressing this button will reset the system, shut off the alarm and clear the failure condition. The Reset button must be pressed before performing another test or changing any of the setup parameters. This button also serves as an abort signal to stop any test in progress.
2. **TEST BUTTON:** Starts a test.
3. **GRAPHIC LCD:** 320 X 240 Monographic LCD.
4. **SOFT KEYS:** Multifunction keys used to select screens and change parameters.
5. **NUMERIC DATA ENTRY:** Keys used to enter numeric data.
6. **UP, DOWN, LEFT, AND RIGHT, ARROW KEYS:** Keys used to scroll the highlighted area or cursor, up and down, left and right. When more than 5 steps are programmed in a test file, the left and right arrow keys will page through the screens of steps. The screens where the paging function is available are as follows: Setup Tests, Perform Tests, Results Summary, and Results
7. **POWER SWITCH:** Turns the Hipot tester ON or OFF.
8. **EXIT KEY:** Key used to escape from parameter editing and return to prior screens.

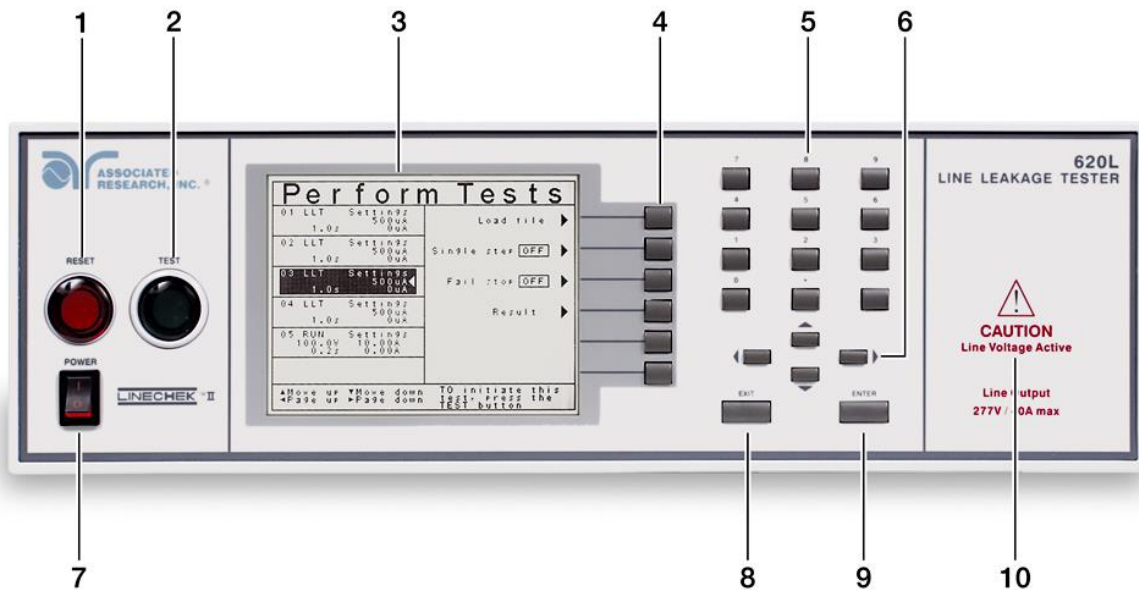

**9. ENTER KEY:** Key used to finalize parameter entries. The ENTER key may also be used to scroll the highlighted area to different parameters in the parameter setting screens.

**10. LINE VOLTAGE INDICATOR:** This indicator flashes to warn the operator that line voltage is present at the voltage output terminal.

### 3.2.2. Rear Panel Controls

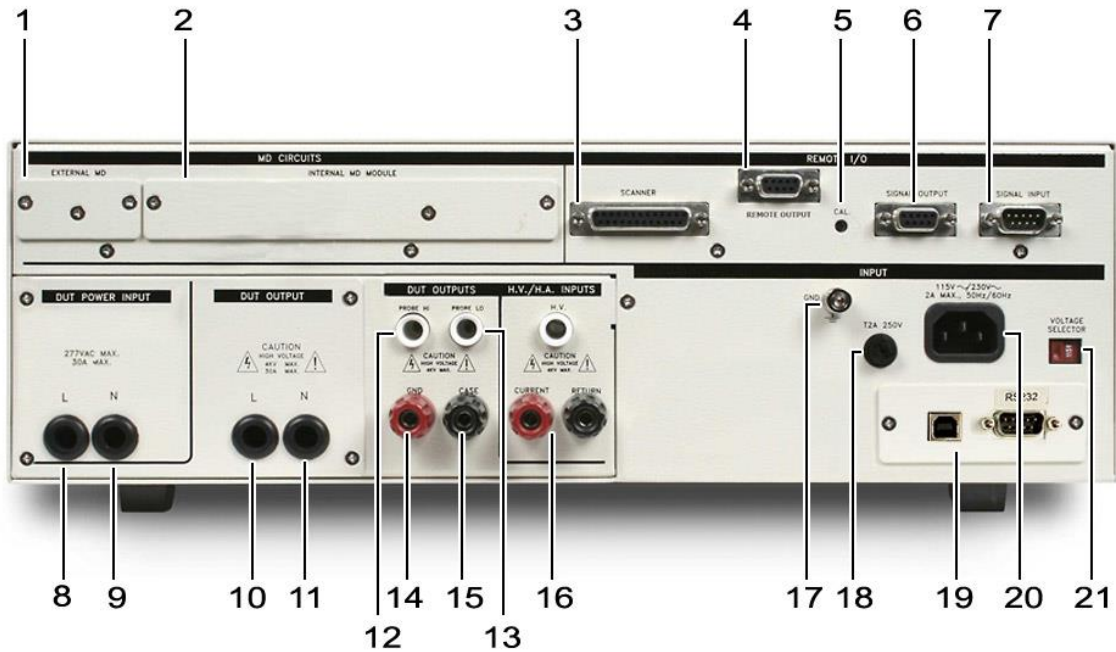

1. **EXTERNAL MEASURING DEVICE:** Contains an external Measuring Device PCB that will enable during a Line Leakage test when “External” is selected from the “Meas. Device” soft key. The external MD allows the operator to configure a custom measuring device using either a simple resistive component or a complex two pole network.
2. **INTERNAL MD MODULE:** Provides the operator access to the measuring device that is currently selected.
3. **SCANNER CONNECTOR:** For connection of optional external 8 channel Scanner. For more information refer to section **8. Options**.
4. **REMOTE OUTPUT:** For connection of optional AC1000 power source. When used to deliver DUT power, the AC1000 may be configured to work in a master/slave mode with the 620L. For more information refer to section **8. Options**.
5. **CALIBRATION BUTTON:** To put the instrument into the calibration mode push this button and turn on the power switch simultaneously.
6. **REMOTE SIGNAL OUTPUT:** 9-Pin D-type subminiature female connector for monitoring PASS, FAIL, and PROCESSING output relay signals (See section **6. Connection of Remote I/O** for more detailed information).

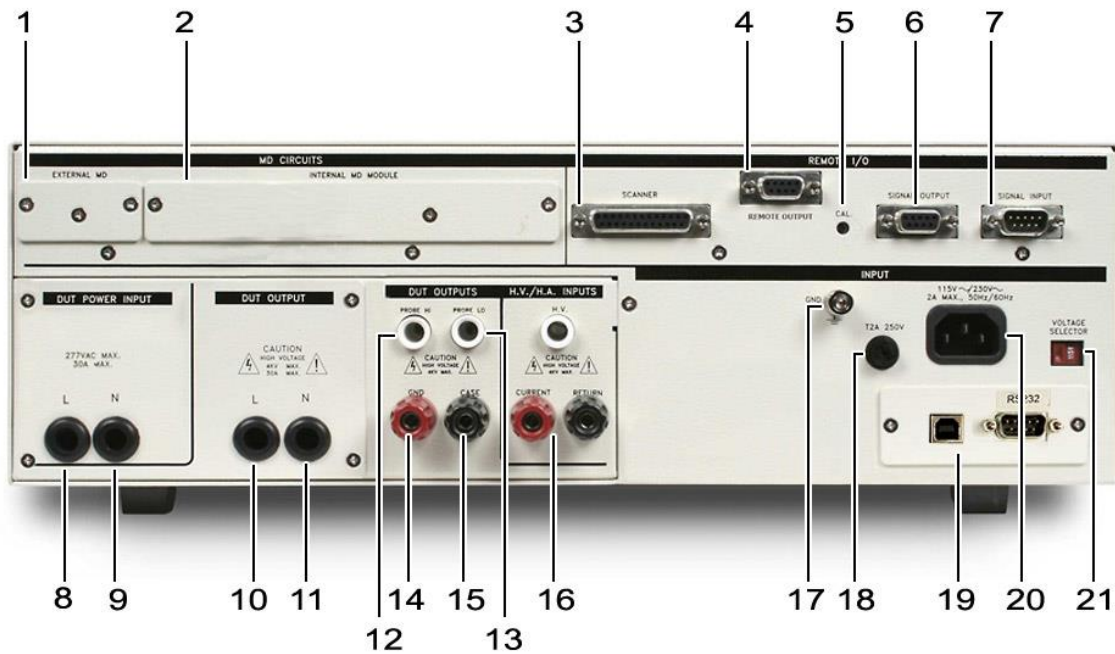

7. **REMOTE SIGNAL INPUT:** 9-Pin D-type subminiature male connector for remote control of TEST, RESET, and REMOTE INTERLOCK DISABLE functions, as well as MEMORY SELECTION (See section 6. **Connection of Remote I/O** for more detailed information).
8. **DUT POWER INPUT LINE:** Provides DUT input power (line connection). Only a single phase unbalanced power source may be used.
9. **DUT POWER INPUT NEUTRAL:** Provides DUT input neutral power (neutral connection). Only a single phase unbalanced power source may be used.
10. **DUT POWER OUTPUT:** Provides line power (line connection) to the DUT during Line Leakage and Functional Run testing.
11. **DUT POWER OUTPUT:** Provides line power (neutral connection) to the DUT during Line Leakage and Functional Run testing.
12. **PROBE HI:** Connector used to attach the Probe-HI test lead to the DUT. When used with an appropriate test lead, this terminal connects one side of the MD (measuring device) to the DUT during Enclosure or Applied Part Line Leakage tests. This terminal will be enabled during a Line Leakage test whenever Probe-HI has been selected.

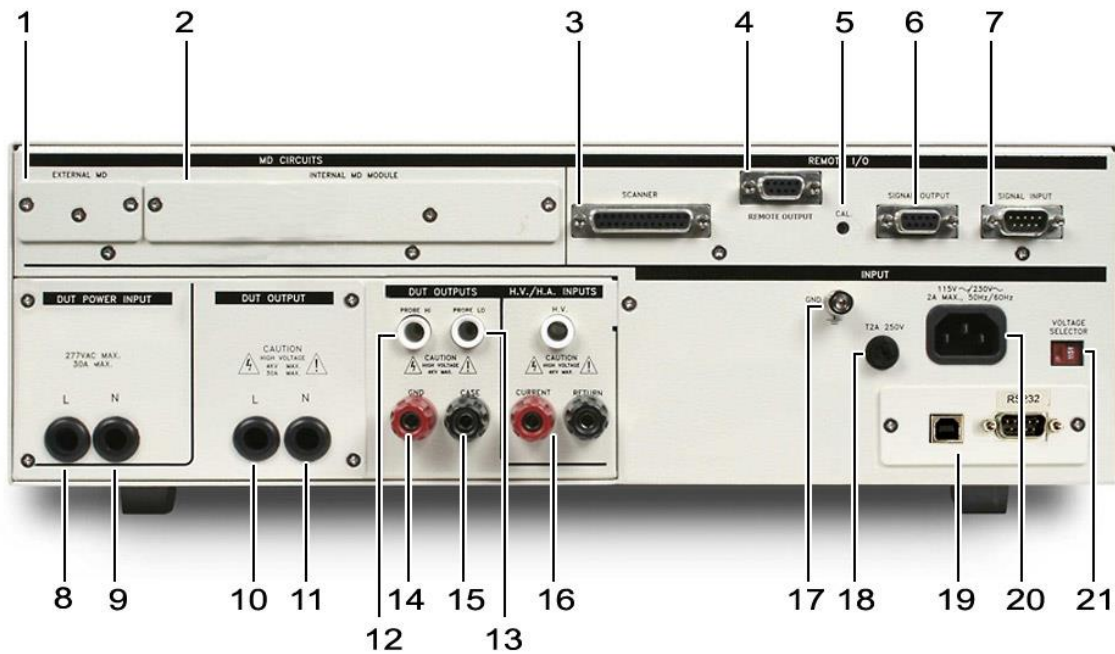

- 13. PROBE LO:** Connector used to attach the Probe-LO test lead to the DUT. When used with an appropriate test lead, this terminal connects one side of the MD (measuring device) to the DUT during Applied Part Line Leakage tests. The terminal is always used in conjunction with the Probe-HI terminal.
- 14. GND:** Connector used to attach the adapter box Ground lead to the instrument.
- 15. CASE (Optional):** Connector used to attach the return lead to the DUT case or dead metal. Provides the return for the Ground Bond, Dielectric Withstand, and Insulation Resistance tests. During a Line Leakage test and Functional Run test, this terminal is isolated from the test circuits. See section **8. Options** for more information.
- 16. Safety Tester Connections (Optional):** Connector used to interface the 620L to an Associated Research electrical safety tester. See section **8. Options** for more information.
- 17. CHASSIS GROUND (EARTH) CONNECTION:** This terminal should be connected to a good earth ground before operation.
- 18. FUSE RECEPTACLE:** To change the fuse, unplug the power (mains) cord and turn the fuse receptacle counter-clockwise. The fuse compartment will be exposed. Please replace the fuse with one of the proper rating.



- 19. BUS INTERFACE:** Standard connector for interconnection to the USB/RS-232 Bus interface. Optional IEEE-488 interface may be substituted for the USB/RS-232.

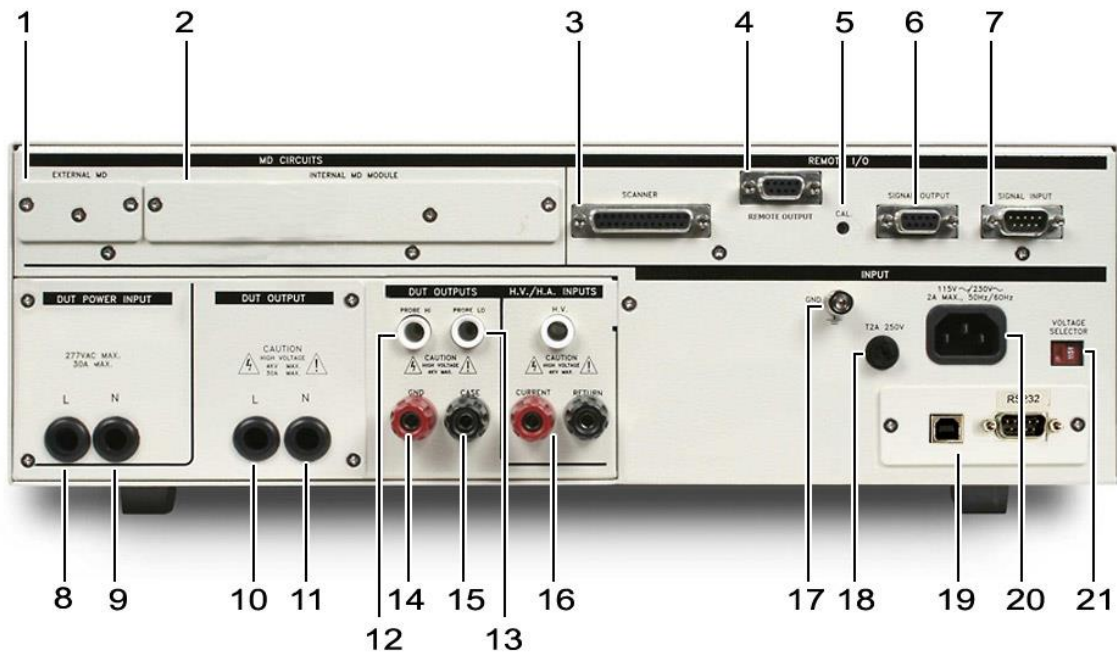

**20. INPUT POWER RECEPTACLE:** Standard IEC 320 connector for connection to a standard NEMA style line power (mains) cord.

**21. INPUT POWER SWITCH:** Sets the line voltage configuration of the instrument. In the left position it is set for 115 volt operation, in the right position it is set for 230 volt operation.

## 4. PROGRAMMING

### 4.1. Power Up

The 620L automatically defaults to the Main Menu screen upon power up. The Main Menu screen will appear as follows:

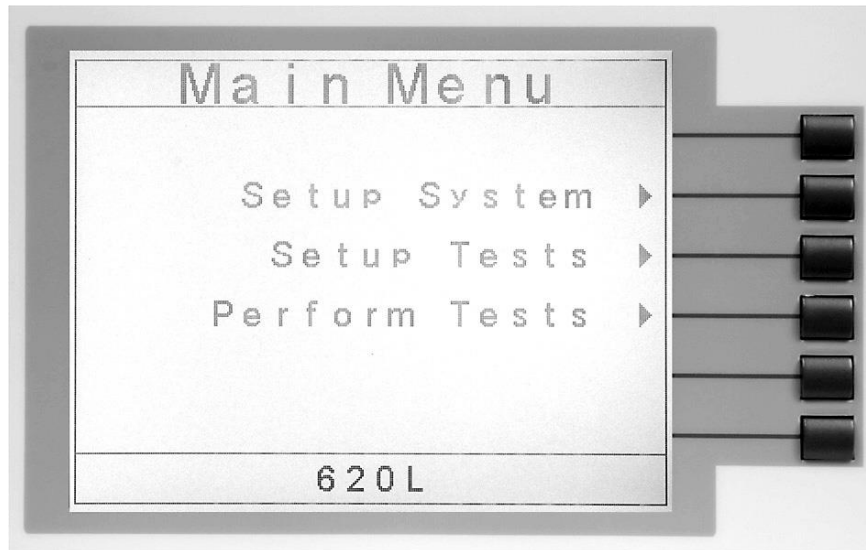

From the Main Menu screen three menus may be accessed: Setup System, Setup Tests, and Perform Tests.

### 4.2. Setup System

From the Main Menu screen press the "Setup System" soft key. The Setup System screen will now be displayed. From the Setup System screen six different hardware and software controls may be accessed: Time and Date, Calibration Alert, Hardware, Security, Power-On Screens. Pressing the EXIT key at any time will return you to the Main Menu screen.

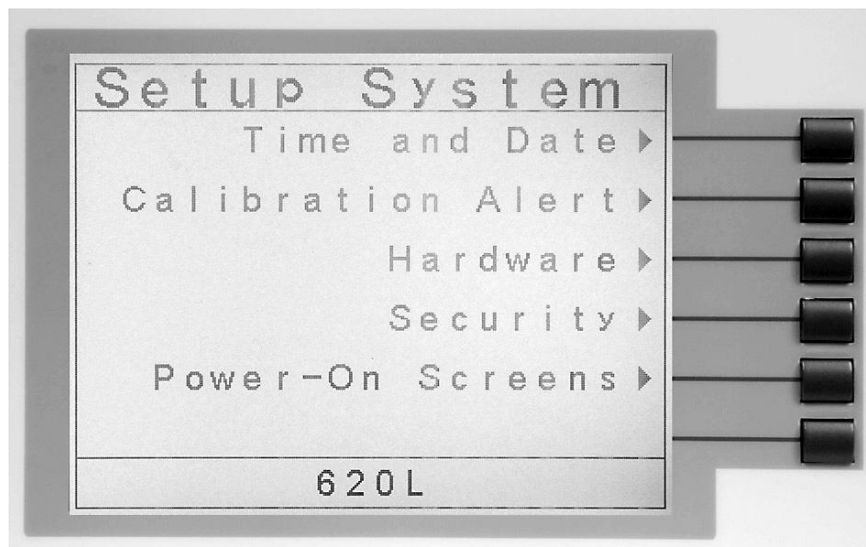

### 4.2.1. Setup System Keys

#### Soft Keys

In the Setup System screen, the soft keys correspond to several setup screens. Use the soft keys to enter the corresponding system screen. Once a system screen has been entered, the soft keys can be used to edit parameters. Press the soft key to edit the corresponding parameter. ENTER does not need to be pressed to confirm the values that the soft keys have been used to change.

#### Directional Keys < >, ^, v

The “< , >, ^, v” keys are used to scroll the cursor to the different system parameters.

#### ENTER

The ENTER key is used to confirm a value for a particular parameter.

#### EXIT

The EXIT key is used to return to the Perform Tests screen from the Setup System screen or will bring you back to the Setup System screen from the various system screens.

### 4.2.2. Time and Date

From the Setup System screen press the “Time and Date” soft key. The Time and Date Setting screen will now be displayed. From this screen, five different parameters may be accessed: Set Date, Set Time, Set Day, Date Format and Time Format. The Time and Date Setting screen will appear as follows:

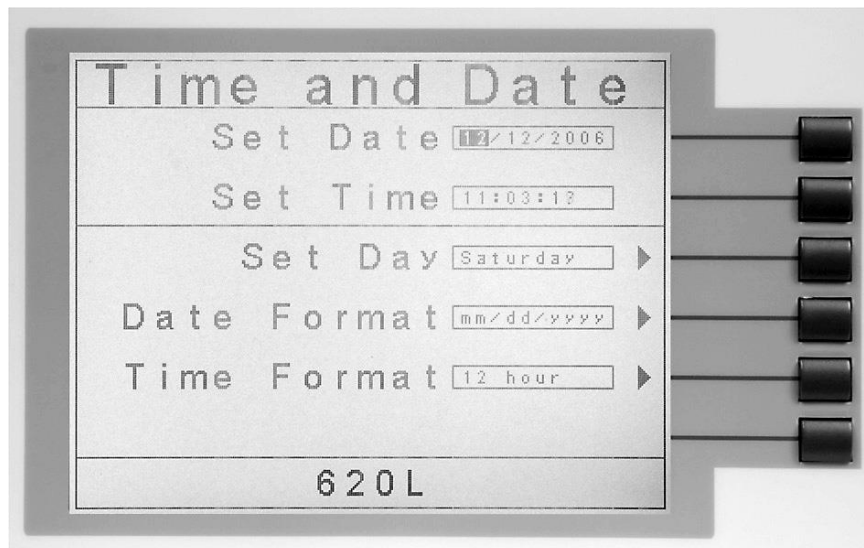

#### Set Date

From the Time and Date Setting screen highlight the Set Date parameter by using the up and down arrow keys. Within the Set Date parameter there are three separate fields: month, day, and year. Using the left and right arrow keys select the field within

the date that you want to edit. Using the numeric keypad enter the new number. Once a parameter is edited, it is necessary to complete the edit either by pressing the ENTER key to accept the new number or the EXIT key to escape from the edit and return to the original number.

### **Set Time**

From the Time and Date Setting screen highlight the Set Time parameter by using the up or down arrow keys. Within the Set Time parameter there are three separate fields: hours, minutes, and seconds. Use the left and right arrow keys to select the field within the time parameter you want to edit. Use the numeric keypad to enter the new number. Once a parameter is edited, it is necessary to complete the edit either by pressing the ENTER key to accept the new number or the EXIT key to escape from the edit and return to the original number.

### **Set Day**

From the Time and Date Setting screen press the “Set Day” soft key. As the soft key is pressed the display will toggle between the seven days of the week.

### **Date Format**

From the Time and Date Setting screen press the “Date Format” soft key. As the soft key is pressed the displayed date will toggle between two different date formats: yyyy/mm/dd or mm/dd/yyyy.

### **Time Format**

From the Time and Date Setting screen press the “Time Format” soft key. As the soft key is pressed, the time format will toggle between 12 hour and 24 hour modes.

### **4.2.3. Calibration Alert**

Calibration Alert is a feature that allows the instrument to give an advanced alert before calibration for the instrument is due. From the System Setup screen press the “Calibration Alert” soft key. The Cal. Alert Setting screen will now be displayed. From the Cal. Alert Setting screen, three different parameters may be accessed: Cal. Due, Alert Date, Cal. Alert. The Cal. Alert Setting screen also displays the date of the last performed calibration. The Cal. Alert Setting screen will appear as follows:



### **Calibration Date**

The Calibration Date shows when the unit was last calibrated at the factory. It is recommended that calibration be performed at least once a year.

### **Calibration Due Date**

It is recommended that the Calibration Due Date not be set greater than one year from the Cal. Date displayed.

From the Cal. Alert Setting screen highlight the Cal. Due parameter by using the up or down arrow keys. The up and down arrow keys will toggle the highlighted area of the screen between the Cal. Due and Alert Date.

Using the left and right arrow keys and the numeric keypad enter the Calibration Due Date. Press the ENTER key to finish.

To change the Date format, see section **4.2.2.Time and Date**.

### **Alert Date**

The Alert Date is like an alarm clock that will warn you in advance of the actual Calibration Due Date. After a calibration is performed the Alert Date is automatically set 11 months after the calibration date. For example, if the calibration is performed on 12/15/2001 the Alert Date will automatically be set to 11/15/2002. Although this date is automatically written into the Alert Date location, it may be manually overwritten to any advanced date desired.

At the Cal. Alert setting screen, highlight the Alert Date parameter by using the up or down arrow keys. The up and down arrow keys will toggle the highlighted area of the screen between the Cal. Due and Alert Date.

Within the Alert Date parameter are three separate fields: month, day, and year. Using the left and right arrow keys select the field you want to edit. Using the numeric keypad enter the new number. Once you begin typing a new number the parameter will blank and the cursor will begin blinking. This indicates that the parameter is being edited. Once a parameter is edited, it is necessary to complete the edit either by pressing the ENTER key to accept the new number or the EXIT key to escape from the edit and return to the original number.

The Calibration Alert Warning screen appears as follows:



At the Calibration Alert Warning screen there are two options: “Show this screen again?”, and OK. “Show this screen again?” is asking if you would like to continue seeing the Calibration Alert Warning screen every time you power up the instrument. You may turn this screen OFF by toggling to the word “No” using the soft key next to this parameter. If the instrument is password-protected you will need to enter the password in order to turn off the “Show this screen again” parameter. Selecting the “Show this screen again” parameter OFF will disable the Calibration Alert function. Pressing the “OK” soft key will exit the Calibration Alert Warning screen and the instrument will power up as usual.

### **Calibration Alert On/Off**

From the Cal. Alert Setting screen you may turn the Calibration Alert function ON and OFF by pressing the “Cal. Alert” soft key. If the “Show this screen again?” function has been turned OFF at the Calibration Alert Warning screen this parameter will automatically be set to OFF. Turning this parameter ON will activate the Cal. Alert function and when the date matches the Alert Date the instrument will display the Calibration Alert Warning screen upon power up.

#### 4.2.4. Hardware

From the Setup System screen press the “Hardware” soft key. The Hardware Setting screen will now be displayed. From the Hardware Setting screen, four different parameters may be accessed: Alarm Volume, LCD Contrast, GPIB Address (this parameter will only appear if a Option 01 GPIB has been installed), and PLC Remote. The Hardware Setting screen will appear as follows:

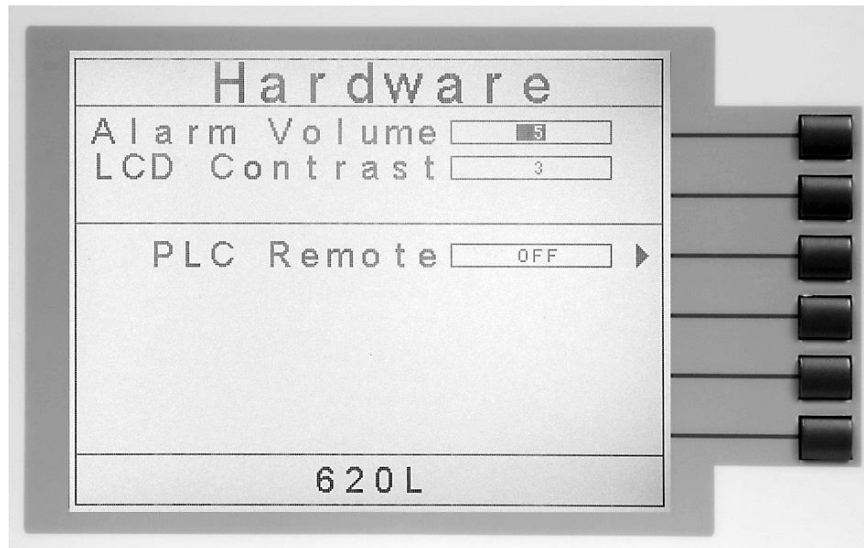

##### **Alarm Volume**

From the Hardware Setting screen highlight the Alarm Volume parameter by using the up or down arrow keys.

Use the numeric keypad to set the instrument’s alarm volume. The numbers correspond to the different volume settings 0 through 9, 0 meaning the volume is OFF, and 9 being the loudest setting. After the number is entered a momentary alarm chirp will occur to indicate the volume of the new setting.

##### **LCD Contrast**

From the Hardware Setting screen highlight the LCD Contrast parameter by using the up or down arrow keys.

Using the up and down arrow keys and the numeric keypad set the contrast of the display. The numbers correspond to different contrast settings are 0 through 9, 0 meaning the lightest color of displayed characters and 9 meaning the darkest color of displayed characters. After the number is entered the display will automatically adjust to the new display setting.

##### **GPIB Address**

From the Hardware Setting screen highlight the GPIB Address parameter by using the up or down arrow keys. Use the numeric keypad to select the GPIB Address number between 0 and 30. Finish by pressing the ENTER key.



### PLC Remote

From the Hardware Setting screen you may turn the PLC Remote ON and OFF by pressing the “PLC Remote” soft key. When the PLC Remote is turned ON the front panel TEST button is disabled and a test may only be initiated through the rear panel I/O. If you attempt to start a test from the front panel TEST button when the PLC Remote function is turned ON, a pop-up message will be displayed. The pop-up message will appear as follows:

### DID YOU KNOW?

You can control your Associated Research, Inc. instrument using basic PLC inputs and outputs. Execute tests and read PASS/FAIL conditions remotely, select memory locations, or set up a safe work station by using an interlocked enclosure.

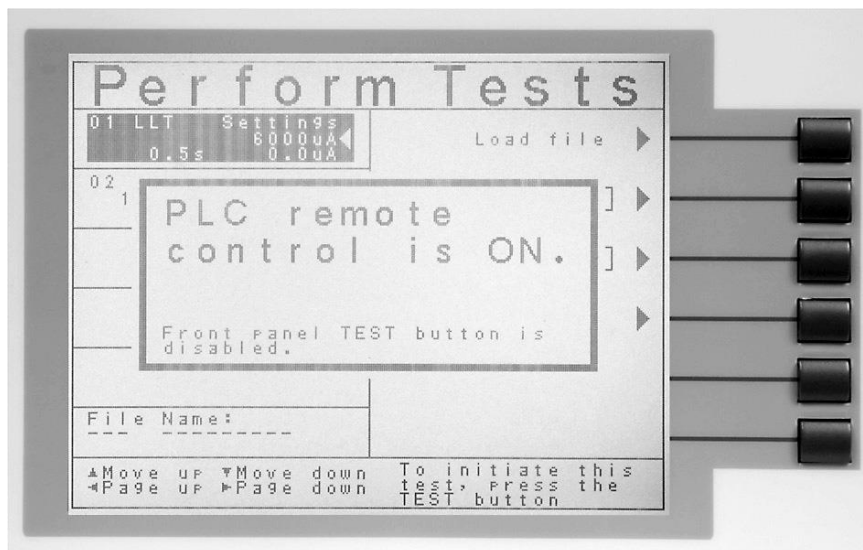

Refer to the section **6. Connection of Remote I/O** for details.

#### 4.2.5. Security

From the Setup System screen press the “Security” soft key. One of two possible Security screens will be displayed. When the instrument is shipped from the factory there is no set password. Initially, the instrument will not have a password enabled and the Security Setting screen will appear.

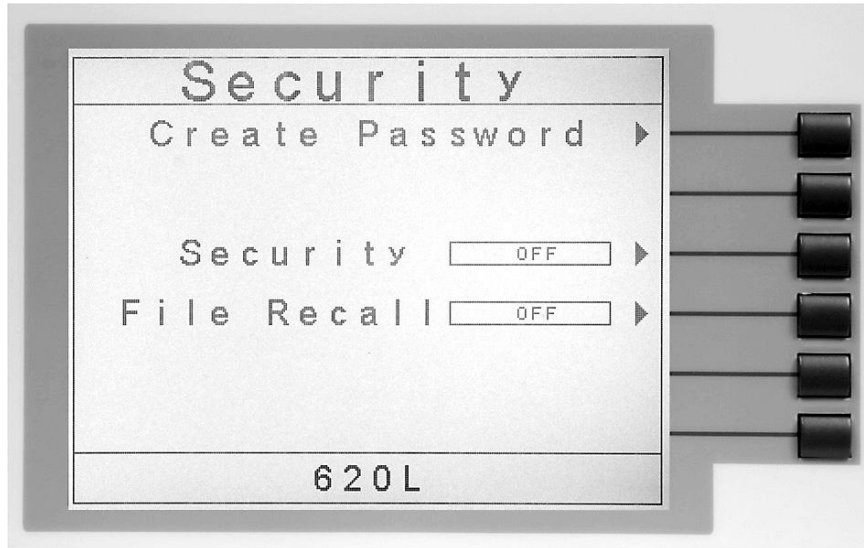

You may create a password from this screen so that all security functions will require a password. From the Security Settings screen, three different parameters may be accessed: Create Password, Security and File Recall.



If a password has already been created the Security Password screen will appear and you must enter the correct password to access the Security Setting screen. From the password-protected Security Setting screen, three different parameters may be accessed: Change Password, Security and File Recall. The Security Setting screen

that will appear after a password has been created and entered correctly will appear as follows:



### **Create Password**

From the initial Security Setting screen you may create a password by pressing the "Create Password" soft key. The Password Setting screen will now be displayed. The Password Setting screen will appear as follows:



You may now type in the new password using the numeric keypad. Press the ENTER key to accept the new password or press the EXIT key to escape. After you type in your new password, you will be required to confirm your new password by typing it again into the "Confirm Password" field. Press the ENTER key to confirm the new password or press the EXIT key to escape.

### **Change Password**

From the Security Setting screen you may change the security password by pressing the “Change Password” soft key. Once you press the “Change Password” soft key the Password Setting screen will appear.

### **Security**

From the Security Setting screen you may turn the security function ON and OFF by pressing the “Security” soft key. Selecting security ON restricts access to parameter settings. The level of security is determined by the File Recall function.

Whenever security is selected ON, the “Single Step” and “Fail Stop” soft keys will be disabled at the Perform Test screen (for more information refer to sections **5.2.2.**

**Single Step** and **5.2.3. Fail Stop**).

- **Note:** Whenever security is enabled you may only start a test file at test step 01.

### **File Recall**

File Recall is a sub-function of the security setting. In order for the File Recall function to work security must first be turned ON. From the Security Setting screen you may turn the File Recall function ON and OFF by pressing the “File Recall” soft key.

Selecting File Recall ON will allow the user to access all available test files but still restricts access to file editing capability. Selecting File Recall OFF will only allow the user to run the currently loaded test file.

### **Disabling the password**

To disable the password simply change the password to “0”. After the password is reset to “0” all security functions may be accessed without using a password.

### **Forgotten Password**

If you have forgotten your password you may access all security functions by typing in the number “0600” into the password field. The old password cannot be recovered. A new password should be entered or enter “0” to disable the password.

### **4.2.6. Power-On Screen**

The Power-On screen allows you to select the screen(s) that will be displayed when the instrument is first powered up. From the System Setup screen, press the “Power-On Screens” soft key. The Power-On screen will now be displayed. The Power-On screen will appear as follows:



From the Power-On screen, two different parameters may be accessed: 620L Info and Main Menu.

### **620L Info**

The 620L Information screen is the very first screen to appear when the instrument is powered up. You have the option to PAUSE the instrument at this screen after power up or CONTINUE through to the next screen after the Information screen is displayed for four seconds. The option to PAUSE or CONTINUE may be selected by pressing the “620L Info” soft key. When PAUSE is selected the words “Press any key to continue” will appear at the bottom of the 620L Information screen.

### **Main Menu**

When the Main Menu parameter is ON the first display to appear after the 620L Information screen is the Main Menu. When the Main Menu parameter is OFF the first display to appear after the 620L Information screen is the Perform Test screen.

### **DID YOU KNOW?**

You can configure the 620L to go directly to the Perform Test screen.

1. Set 620L Info to CONTINUE.
2. Set the Main Menu selection to OFF. Now when the instrument is powered up it will go directly to the Perform Test screen.

### 4.2.7. Default System Parameters

SETUP SYSTEM	
PLC Remote	OFF
Address (GPIB only)	9
Contrast	5
Volume	5
SECURITY	
Password	0
Security	OFF
File Recall	OFF

### 4.3. Setup Tests Menu

From the Main Menu screen press the “Setup Tests” soft key. The Setup Tests screen will now be displayed. From the Setup Tests screen, six different software controls may be accessed: Add, Edit, Delete, Prompt, File, and Fail Stop. The Setup Tests screen will appear as follows:

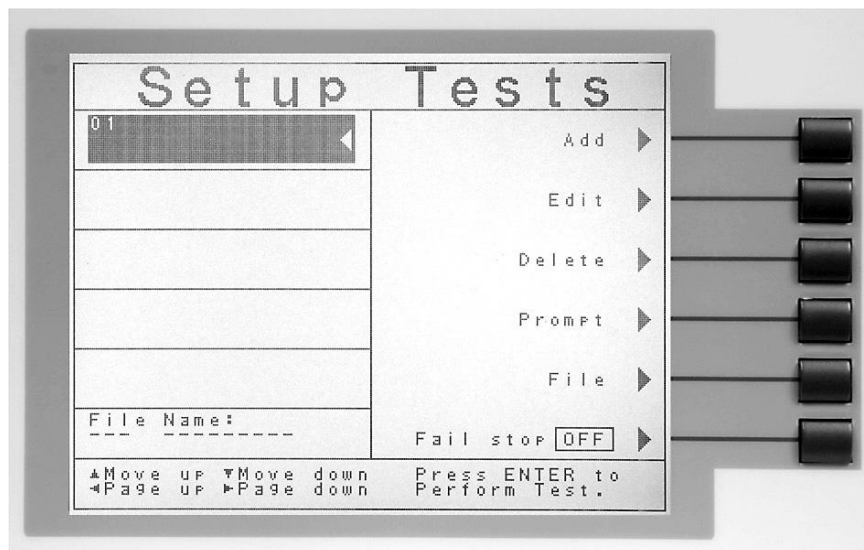

The Setup Tests screen is the central starting point for programming tests into the instrument. From this screen test parameters are entered and edited, and the order of the test steps is arranged. The 620L is capable of performing a 30-step sequential test from a single test file.

The Setup Tests screen is separated into two main sections. The left half of the screen lists the steps and the parameters contained within each step. The right half of the screen contains the Soft Key menu. When more than 5 steps are programmed in a test file, the left and right arrow keys will page through the screens of steps. Individual steps may be scrolled to using the up and down arrow keys.

#### 4.3.1. Add

From the Setup Tests screen press the “Add” soft key. From this screen you may select what type of test you wish to add to a test sequence: Line Leakage test or Functional Run test (requires Option 02 Run Test Function, see section **8.Options** for more information). The Test Selection screen will appear as follows:

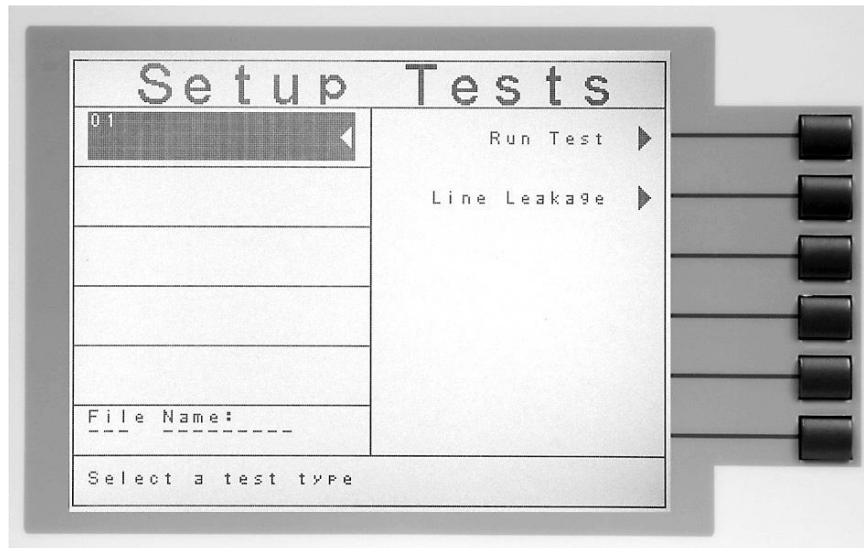

For a detailed description of the screens and parameters that are associated with soft keys on this screen please refer to section **4.4. Test Parameters**.

#### 4.3.2. Edit

From the Setup Tests screen use the up and down arrow keys to scroll the highlighted area to the step you wish to edit. Press the “Edit” soft key. The Parameter Setting screen for the type of test that is in that location will now be displayed. The parameters for the test may now be edited.

For a detailed description of the screens and parameters that are associated with the “Edit” soft key please refer to section **4.4. Test Parameters**.

#### 4.3.3. Delete

From the Setup Tests screen use the up and down arrow keys to scroll the highlighted area to the step you wish to delete. Press the “Delete” soft key to remove the step.

#### 4.3.4. Prompt

The Prompt function allows you to insert a short line of text in a step. The Prompt will appear on the screen before the step is initiated and remain on the screen until the TEST button is pressed. After the TEST button is pressed the Prompt will clear and the step will initialize. Use the up and down arrow keys to scroll the highlighted area to the step where you would like to insert the text prompt and press the “Prompt” soft key. The Prompt screen will now be displayed. The Prompt screen will appear as follows:

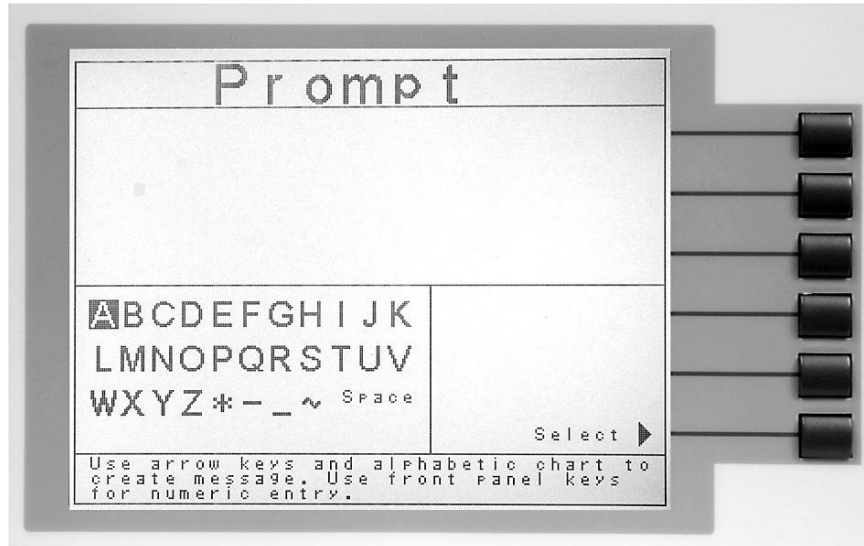

To enter a Prompt use the arrow keys to scroll the highlighted area to the character (or enter a number from the numeric keypad) you wish to use and then press the “Select” soft key. If you make a mistake or want to change the character press the backspace key “←” in the numeric keypad. When you have finished editing the Prompt press the ENTER key. After a Prompt is inserted in a step, a “P” will appear within the step parameters below the step number.

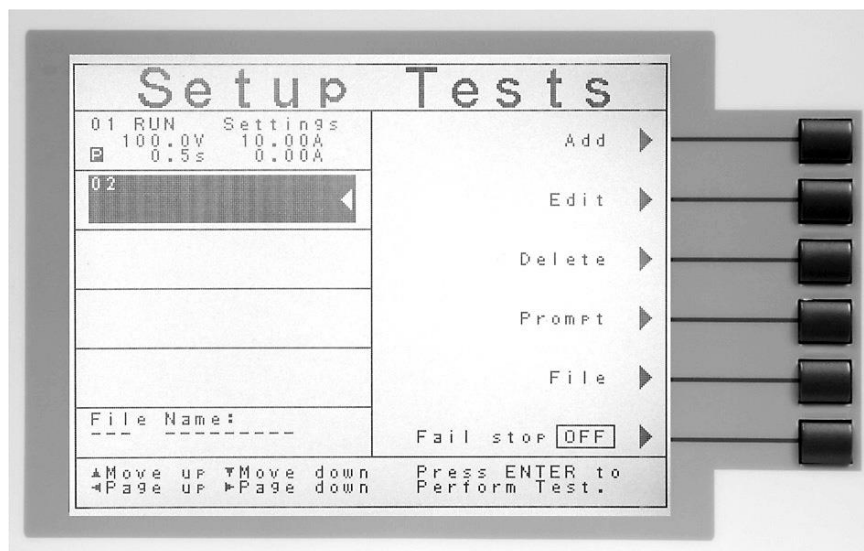

In order to delete a previously create prompt, use the up and down arrow keys to scroll the highlighted area to the step where you would like to delete the text prompt and press the “Prompt” soft key. The Prompt screen will now be displayed. Use the backspace key “←” to delete the text. Press the EXIT key to return to the Setup Tests screen.



### 4.3.5. File

From the Setup Tests screen press the “File” soft key. The File Setup screen will now be displayed. From the File Setup screen, five different file-handling controls may be accessed: New File, Save, Save As, Delete, and Load. The File Setup screen will appear as follows:

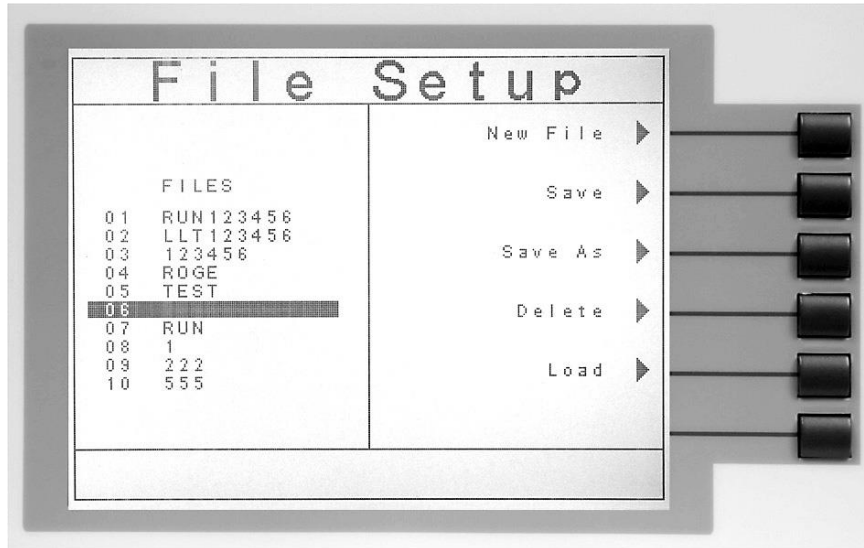

#### New File

From the File Setup screen press the “New File” soft key. The Create File screen will now be displayed. For a detailed description of creating a new file refer to the section 4.5. Setting Up a Test. The Create File screen will appear as follows:

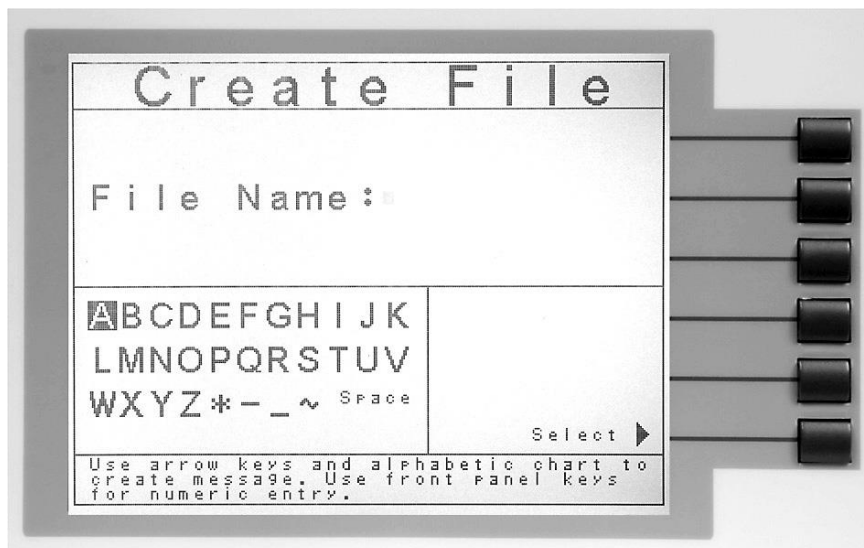

#### Save

To save a file with its current name press the “Save” soft key in the File Setup screen.

**Save As**

To save an edited file without overwriting the original or to give a file a new name, press the “Save As” soft key in the File Setup screen.

**Delete**

To delete a file use the up and down arrow keys and scroll the highlighted area to the file you wish to delete. Press the “Delete” soft key. A warning will appear on the screen asking if you want to delete the file. Press the ENTER key to complete the deletion or press the EXIT key to escape.

**Load**

To load a test file use the up and down arrow keys and scroll the highlighted area to the file you wish to load. Press the “Load” soft key.

**Connect (conditional)**

If a file is created with 30 test steps the “Connect” soft key will appear in the File Setup screen. Press the “Connect” soft key to connect step 30 of one test file to step 1 of another test file. This feature will only appear if the test file has 30 steps. Only sequential test files may be linked together (i.e. File 01 – File 02).

**4.3.6. Fail Stop**

Fail Stop is a function that will stop a sequence of tests if a failure occurs. If this function is turned OFF the sequence of tests will continue to the end of the sequence regardless of whether or not a failure has occurred. If the Fail Stop is OFF and a failure occurs during the test sequence, the RESET button will light and a short alarm will sound but the sequence will continue. At the end of the test sequence, the RESET button will light and alarm will sound indicating failure during the sequence. Pressing the RESET button will silence the alarm and reset the instrument.

Turn the Fail Stop function ON and OFF by pressing the “Fail Stop” soft key. Fail Stop is a parameter that is stored within the test file but may also be turned ON and OFF temporarily from the Perform Tests screen. If security is enabled you may not turn Fail Stop ON and OFF using the “Fail Stop” soft key. Fail Stop automatically defaults to the setting stored in the file when security is activated.

## 4.4. Test Parameters

### Test Parameter Notes

- Once you begin typing a new number the parameter will go blank and the cursor will begin blinking. This indicates that the parameter is being edited. Once a parameter is edited it is necessary to complete the edit either by pressing the ENTER key to accept the new number or the EXIT key to escape from the edit and return to the original number. The one exception to this rule is the Scanner parameter. The Scanner parameter will not go blank when being edited.
- When the ENTER key is pressed to accept a parameter change, the instrument will automatically highlight the next Test Parameter Edit screen.
- The Test Parameter Edit screen displays the range of the parameter that is highlighted in the lower left corner. Use this as a guide when setting your parameters.
- Selecting the test type (LLT or Run test) automatically loads the default parameters for that particular type of test. Refer to section **4.4.2. Default Test Parameters** for the preset default parameters.

### 4.4.1. Description of Test Parameters

**Voltage-HI:** The maximum voltage allowable at the DUT Power Input Terminal that triggers a failure when exceeded.

**Voltage-LO:** The minimum voltage allowable at the DUT Power Input Terminal that triggers a failure when not exceeded.

**Amp-HI:** The maximum current allowable at the DUT Power Input Terminal that triggers a failure when exceeded.

**Amp-LO:** The minimum current allowable at the DUT Power Input Terminal that triggers a failure when not exceeded.

**Leakage-HI:** The maximum leakage current allowable through the measuring device that triggers a failure when exceeded.

**Leakage-LO:** The minimum leakage current allowable through the measuring device that triggers a failure when not exceeded.

**Power-HI:** The maximum allowable power consumption by the DUT that triggers a failure when exceeded.

**Power-LO:** The minimum allowable power consumption by the DUT that triggers a failure when not exceeded.

**PF-HI:** The maximum allowable Power Factor that triggers a failure when exceeded.

**PF-HI:** The minimum allowable Power Factor that triggers a failure when not exceeded.

**Dwell Time:** The length of time that is allowed for the programmed test voltage to be applied.

**Delay Time:** The length of time that the programmed test voltage is applied but no judgment of the set parameters is made. Judgment of the parameters is not made until the end of the delay time.

**Neutral:** The status of the neutral relay used during Line Leakage testing. Can be OPEN or CLOSED.

**Reverse:** The status of the reverse relay used during Line Leakage testing. Can be ON or OFF.

**Ground:** The status of the ground relay used during Line Leakage testing. Can be set to OPEN or CLOSED.

**Meas. Device:** The measuring device (MD) selected for the Line Leakage test.

**Probe:** The points at which the measuring device are placed during the Line Leakage test. Can be set to: "G-L", "Ph-L", and "Ph-PI".

**Leakage:** Leakage measurement setting used during the Line Leakage test. Can be set to RMS or Peak.

**Extended Meters:** The metered values displayed during a Line Leakage test. Can be set to ON or OFF. When set to ON, I-Maximum RMS and MD Voltage RMS are displayed during a Line Leakage test. When set to OFF, Voltage and Leakage RMS are displayed during a Line Leakage test.

**AC/DC:** The metered value of leakage current during a Line Leakage test. Can be set to AC+DC, AC or DC. When set to AC+DC, the unit measures the composite leakage current through the MD. When set to AC, the unit measures only the AC component of the leakage current through the MD. When set to DC, the unit measures only the DC component of the leakage current through the MD\*.

\*NOTE: If the AC/DC parameter is set to DC or AC, the minimum delay time is automatically set to a minimum of 1.3sec.



**Ranging Mode:** Unit ranging setting used during the Line Leakage test. Can be set to Auto or Manual.

**Continuous:** When active, the Continuous feature keeps the DUT powered from one Line Leakage test to another, from one Functional Run test to another, and in between Line Leakage and Functional Run test steps.

**Scanner (Option):** Sets the Scanner channels to H (for Probe-HI connections), L (for Probe-LO connections), or O (for open). This parameter will only appear when the option 04 Scanner is installed. See section 8. **Options** for more information.

**PLC CONTROL (Option):** Selects the AC1000 memory location (M1-M7) to be used during a Line Leakage or Functional Run test. This parameter will only be displayed when Option 05 Remote Memory Send is installed. See section 8. **Options** for more information.

**Defaults:** Pressing this soft key will default the test parameters to their predetermined default values (refer to section 4.4.2. **Default Test Parameters**). Once the “Default” soft key is pressed it is necessary to complete the edit either by pressing the ENTER key to accept the parameter overwrite or the EXIT key to escape from the edit and return to the original values.

#### 4.4.2. Default Test Parameters

In each of the Test Parameter Setting screens there is a “Defaults” soft key. When this soft key is pressed the test will load with a set of predetermined default parameters. The following table is a listing of the default parameters for each of the different types of tests that are available in the 620L. The default parameters are:

## Default Parameters

TEST TYPE	PARAMETER	VALUE
LLT	Leakage-HI	6000 $\mu$ A
	Leakage-LO	0.0 $\mu$ A
	Voltage-HI	125.0V
	Voltage-LO	0.0V
	Delay Time	0.5s
	Dwell Time	0.5s
	Reverse	OFF
	Neutral	CLOSED
	Ground	CLOSED
	Meas. Device	UL544NP
	Probe	Ground to Line
	Leakage	RMS
	Extended Meters	OFF
	AC/DC	AC+DC
	Ranging Mode	AUTO
	Continuous	OFF
	Run Test	Voltage-HI
Voltage-LO		0.0V
Amp-HI		10.00A
Amp-LO		0.00A
Delay Time		0.5s
Dwell Time		0.5s
Leakage-HI		10.00mA
Leakage-LO		0.00mA
Power-HI		1000W
Power-LO		0W
PF-HI		1.000
PF-LO		0.000
Continuous		OFF

## 4.5. Setting Up a Test

### 4.5.1. General Test Procedures

Upon power up the 620L will initialize with the test file that was last used before power down. If the instrument is new it will come loaded with one default file until it is changed.

1. From the Setup Tests screen press the “File” soft key. The File Setup screen will now be displayed.
2. From the File Setup screen press the “New File” soft key. The Create File screen will now be displayed.
3. The Create File screen is separated into three main sections: Alphabet and Symbols, File Name Edit, and Soft Key Menu.
4. From the Create File screen you must give your new test file a name. The file name can be a maximum of ten characters in length and may use any combination of the character set and numbers. To name the file use the arrow keys to scroll the highlighted area to the character (or enter a number from the numeric keypad) you wish to use and then press the “Select” soft key. If you make a mistake or want to change the character, press the backspace key “←” in the numeric keypad. When you have finished editing the file name press the ENTER key.
5. From the Setup Tests screen press the “Add” soft key. From this screen you may choose what type of test to perform: Line Leakage test or Run test.
6. From the Test Selection screen press the soft key next to the type of test you wish to add to the test sequence. The Parameter Setting screen will now be displayed for the type of test you have chosen.
7. From the Parameter Setting screen you may set the parameters for the test or choose the defaults from the soft key menu. All of the individual parameters for the test may be accessed using the up and down arrow keys and the ENTER key. As the arrow keys are pressed the highlighted area will scroll to the different parameters. The ENTER key may also be used to scroll to the different parameters.
8. Scroll to the parameter you wish to edit. The parameter that is highlighted may now be edited (refer to section **4.4. Test Parameters** for more information). Enter a new number via the numeric keypad. Once a parameter is edited it is necessary to complete the edit either by pressing the ENTER key to accept the new number or the EXIT key to escape from the edit and return to the original number.
9. Press the EXIT key to add this test to the sequence of tests. The Setup Tests screen will now be displayed again, this time with the new parameters.

#### DID YOU KNOW?

You can link test files together if more than 30 steps are required for a test sequence. For more information refer to the Connect feature in section **4.3.5. File**.

10. At this point you may add more tests to the sequence, insert tests, insert prompts, perform the test sequence, or store the sequence to the file name you created.

### Adding More tests to the Sequence

To add more tests to the sequence simply repeat steps 5-10 of this section.

### Performing a Test from the Setup Test screen

To perform the test you have just created press the ENTER key. The Setup Test screen will now be displayed along with a pop-up message that appears as follows:

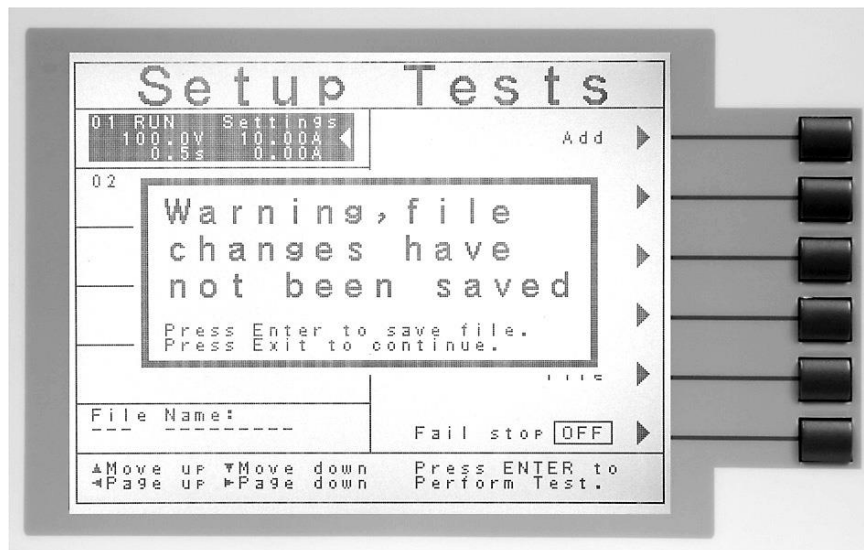

Pressing the ENTER key will store the file with the file name you gave it and go to the Perform Test screen. You may now perform a test (refer to section **5.3. Performing a Test**).

Press the EXIT key to return to the Main Menu without saving the file. Even though the file has not been saved, the file will be retained in RAM until another file is loaded or created, or until the instrument is powered down.

### Saving the Test File

From the Setup Tests screen press the “File” soft key. The File Setup screen will now be displayed.

From the File Setup screen press the “Save” soft key. The file will save with the name you created and the Setup Tests screen will be displayed with the new file loaded.

The instrument is now ready to perform tests with the new file. You may press the ENTER key to go to the Perform Tests screen or press the EXIT key to return to the Main Menu.



### Inserting Tests

From the Setup Tests screen scroll the highlighted area to the step in the sequence where you would like to insert a test. Press the “Add” soft key. The highlighted area will blank and the test that was originally at this step in the sequence, as well as all of following steps, will increment. You may now select the type of test you wish to insert from the soft key menu.

### Inserting a Text Prompt

Refer to section 4.3.4. **Prompt** for a detailed description of inserting text prompts.

### 4.5.2. Line Leakage Test

From the Setup Tests, Tests Selection screen press the “Line Leakage” soft key. The Line Leakage Parameter Setting screen will now be displayed. The Line Leakage Parameter Setting screen will appear as follows:

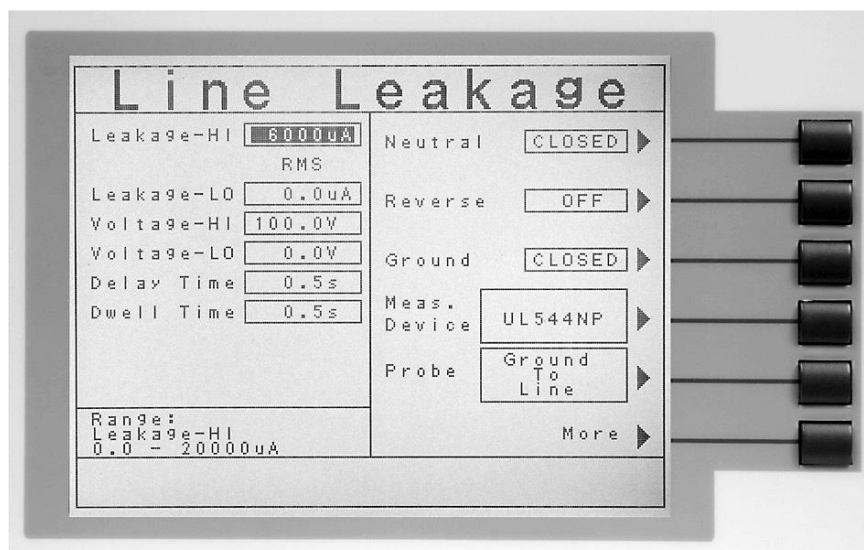

From the Line Leakage Parameter Setting screen, the following parameters may be controlled: Leakage-HI, Leakage-LO, Voltage-HI, Voltage-LO, Delay Time, Dwell Time, Neutral, Reverse, Ground, Measuring Device, Probe, and More. Pressing the “More” soft key will bring up additional parameters: Leakage, Extended Meters, AC/DC, Ranging Mode and Continuous.

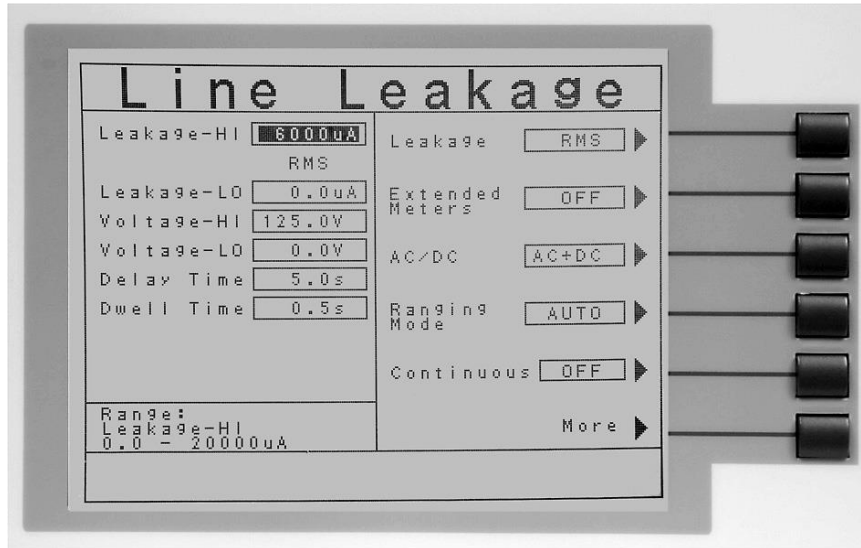

Pressing the “More” soft key will bring two additional choices for Defaults and More:

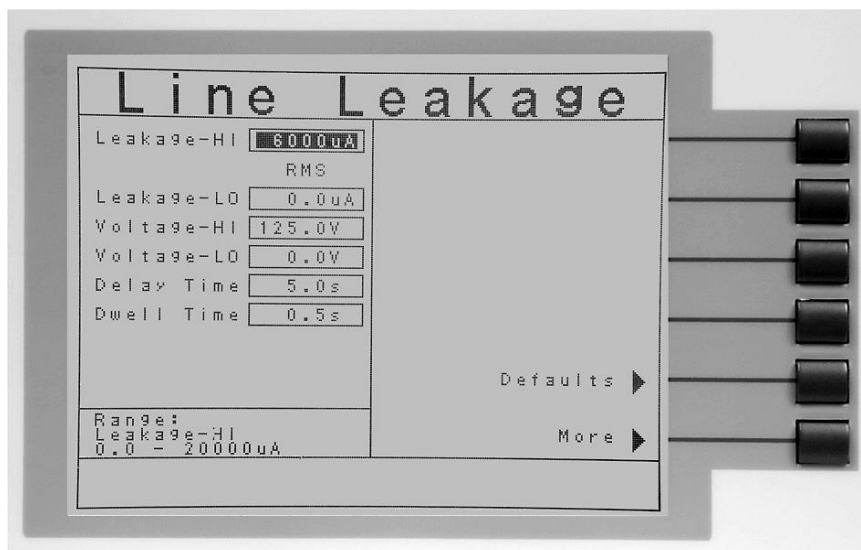

Pressing the “Defaults” soft key will return all parameters to their default values. Pressing the “More” soft key will return the user to the first page of test parameters.

For detailed descriptions of these parameters see below or refer to section **4.4.1. Description of Test Parameters.**

### **Line Configuration Soft keys**

The LINE configuration is determined by the relays S1, S2 and S3 (see Figure below) and is set using the corresponding Line Configuration Soft keys. The S1 relay is represented as NEUTRAL and is controlled by the Neutral soft key. The S2 relay is represented as REVERSE and is controlled by the Reverse soft key. The S3 relay is

represented as GROUND and is controlled by the Ground soft key. Pressing the relay's corresponding soft key will toggle it between its two available states.

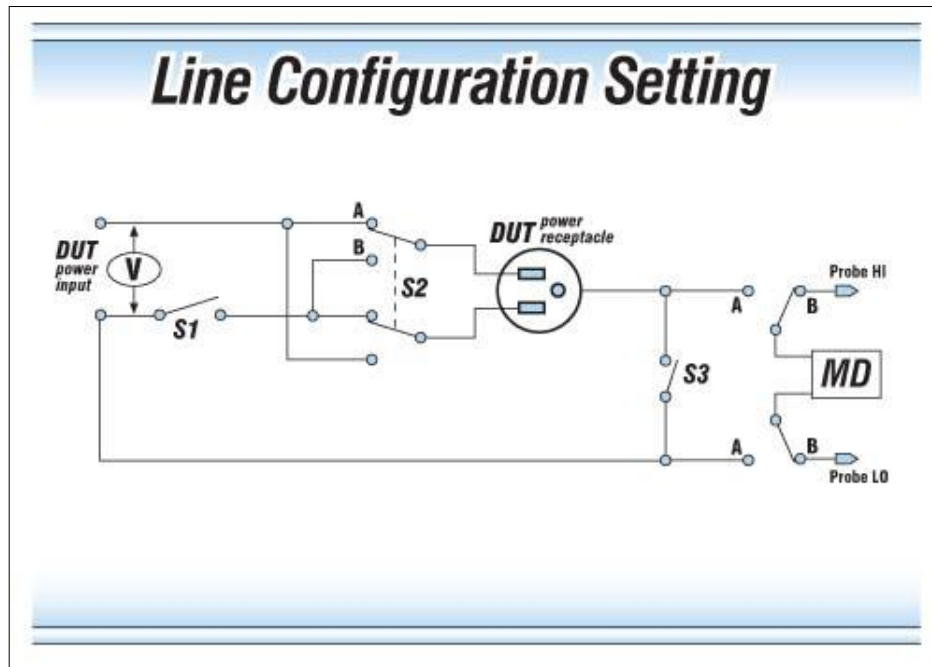

### Line Configuration Setting

When the Neutral or Ground relays are set to the CLOSED position they are in a normal operating condition. When the Neutral or Ground relays are set to the OPEN position they are in a fault condition that represents a fault in the line input wiring.

When the REVERSE relay is set to ON the relay is in position Band the Line and Neutral conductors are reversed at the DUT power outputs.

The three relays may be configured into eight different combinations of Line conditions. The different combinations are represented in the following table.

LINE CONFIG.	NEUTRAL		REVERSE			GROUND	
	Relay/ Soft key	Fault	Soft key	Relay	Fault	Relay/ Soft key	Fault
1	Open	Yes	OFF	A	No	Open	Yes
2	Open	Yes	ON	B	Yes	Open	Yes
3	Open	Yes	OFF	A	No	Closed	No
4	Open	Yes	ON	B	Yes	Closed	No
5	Closed	No	OFF	A	No	Open	Yes
6	Closed	No	ON	B	Yes	Open	Yes
7	Closed	No	OFF	A	No	Closed	No
8	Closed	No	ON	B	Yes	Closed	No

### Probe Configuration

The Probe configuration is controlled by the relays SH and SL shown in the preceding image and are set by the “Probe” soft key. These two relays configure the current measuring device into three possible positions. Repeatedly pressing the Probe soft key allows the selection of the three different states. The three positions are described in the table below.

MEASURING DEVICE POSITION	SH	SL	AGENCY TEST APPLICATION
Ground to Line	A	A	Earth Leakage
Probe HI to Line	B	A	Enclosure Leakage or Patient Leakage
Probe-HI to Probe-LO	B	B	External Applied Part or Surface to Surface Leakage

Ground-to-Line indicates the MD is connected to measure the leakage current in the line cord from the earth ground conductor back to the system neutral. This is referred to as an EARTH LEAKAGE TEST.

Probe-HI to Line indicates the MD is connected between the PROBE HI terminal on the instrument, which should be connected to the ENCLOSURE of the DUT, and the system neutral. This is known as an ENCLOSURE LEAKAGE TEST.

Probe-HI to Probe-LO indicates the MD is connected between the PROBE HI and the PROBE LO terminals on the instrument which allow the operator to connect the MD between applied parts.

### Measuring Device

The Measuring Device is a circuit that simulates the impedance of the human body. The Measuring Device is specified differently for different agencies, applications and specifications. Repeatedly pressing the “Measure Device” soft key will allow you to select one of the many measuring devices listed in the table below. The table below indicates the available measuring devices and the appropriate agency standard to which it correlates.

Cross Reference Letter	Agency Specification	Application
<b>MD1</b>	UL544 Non patient equipment	Medical Equipment
<b>MD2</b>	UL544 Patient care equipment	Medical Equipment
<b>MD3</b>	IEC60601, UL2601	Medical Equipment

<b>MD4</b>	UL1563	Electric Spas, Equipment Assemblies and Associated Equipment
<b>MD5</b>	IEC60990 Fig4-U2, IEC 62368	Laboratory Equipment. Information Technology.
<b>MD6</b>	IEC60990 Fig5-U3	Weighted Touch Current, Let-Go.
<b>External</b>	User configurable	User configurable
<b>Frequency Check</b>	The Line Leakage test can be configured to verify the bandwidth of the leakage current “voltmeter”, by setting the Probe configuration, Probe-HI to Probe-LO, and selecting the medical device “Frequency Check”.	The selection is intended to be used for meter verification only and has no application for normal testing.

### Circuit Diagrams

The following diagrams show the equivalent circuit of the measuring devices. Leakage current readings are generated by measuring the voltage drop across these networks and dividing by the equivalent DC resistance. The voltmeter is placed across the entire network of the measuring devices MD1, MD2, and MD4. The voltmeter is placed across the points indicated by the solid black dots on measuring device MD3, MD5 and MD6. The points are specified by the agencies that require a particular measuring device to meet their specification.

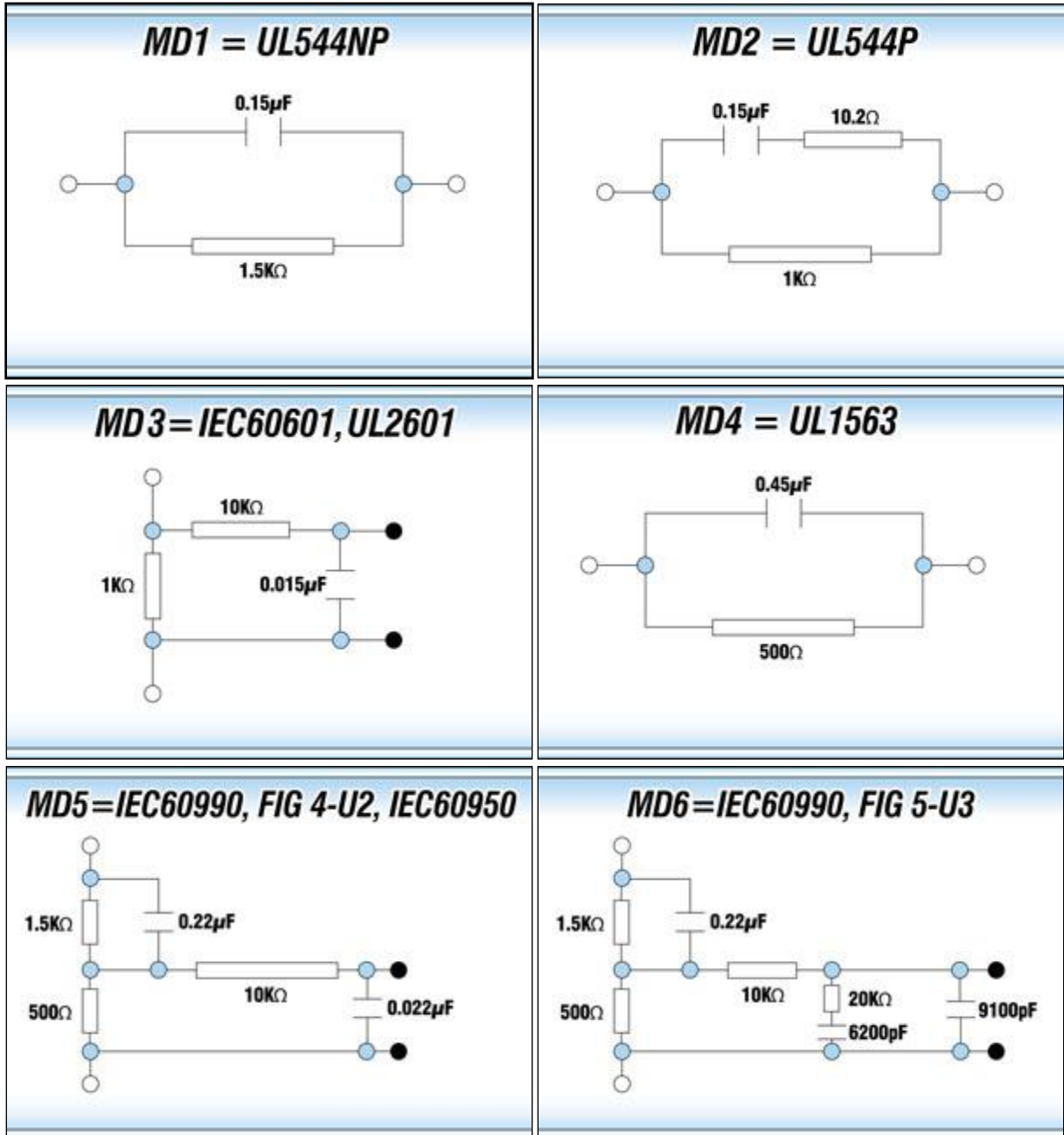

### **External Measuring Device**

The 620L has an access panel on the back of the instrument that can be removed to access the MD external PCB. The MD external PCB may be configured for a simple resistive measuring device or a two pole measuring device similar to MD “E”. No components are supplied for the population of the PCB.

### **Frequency Check**

The Line Leakage test can be configured to verify the bandwidth of the leakage current “voltmeter” by setting the Probe configuration to “Probe-HI to Probe-LO” and selecting the medical device “Frequency Check”. The selection is intended for meter verification purposes only and has no application for normal testing.

The calculation of the displayed leakage current will use  $1000 \Omega$  for R in the calculation of  $V/R=I$  where I is the leakage current displayed and V is voltage across the measuring device (MD). When an external frequency generator is applied to the probe inputs, the current display will be equal to Voltage generator/1000. The readings can then be correlated to verify the voltmeter bandwidth.

Since the voltage is being applied directly across the MD voltmeter amplifier inputs, it is not necessary to actually install a  $1K\Omega$  resistor to the external MD input. It is necessary to have the  $0\Omega$  resistors installed in position R1 and R3 on the external measuring device PCB to operate in this mode. If the external Measuring Device has been populated in a different configuration, it will be necessary to create a temporary short on R1 and R3 to operate in this mode. Another option would be to acquire a spare external measuring device PCB for the meter verification purpose.

### 4.5.3. Scanner

This allows the 620L to be connected to an Associated Research SC6540 Modular Scanning Matrix, model HN. With this option installed and a Scanner connected to the Scanner control bus on the rear of the instrument, the 620L and accompanying Scanner can be used for multi-point Line Leakage testing. The 620L will provide power and all necessary signals to the corresponding Scanner inputs.

In order to connect the Scanner to the 620L, four (4) connections must be made. Connect the Scanner control bus from the Scanner output on the rear panel of the 620L to the input on the rear panel of the Scanner using the included communications cable (p/n 38592). Connect the Probe-HI output on the panel of the instrument to the Current input on the panel of the Scanner. Connect the Probe-LO output on the panel of the instrument to the Return input on the panel of the Scanner.

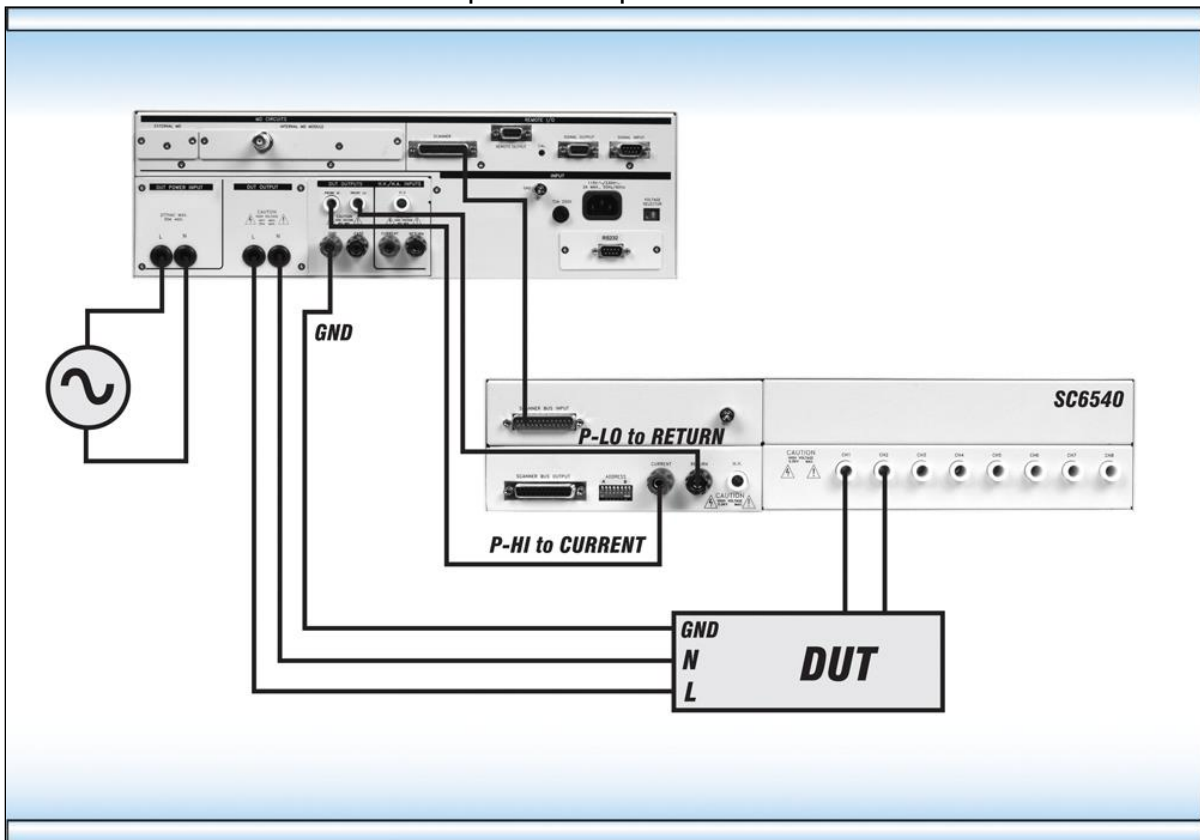

Within the Line Leakage Edit screen, the “Scanner Select” parameter (soft key) will automatically appear when highlighted cursor moves to the Scanner Setup area using the UP and Down Arrow keys or Enter key. Press the “Scanner Select” soft key to toggle the Scanner channel between H (high), L (low), or O (off). Press the Left and Right Arrow keys to move the highlighted cursor to the corresponding Scanner channel. Setting a channel to H will connect the Probe-HI of the 620L to the corresponding Scanner channel. Setting a channel to L will connect the Probe-LO of the 620L to the corresponding Scanner channel.



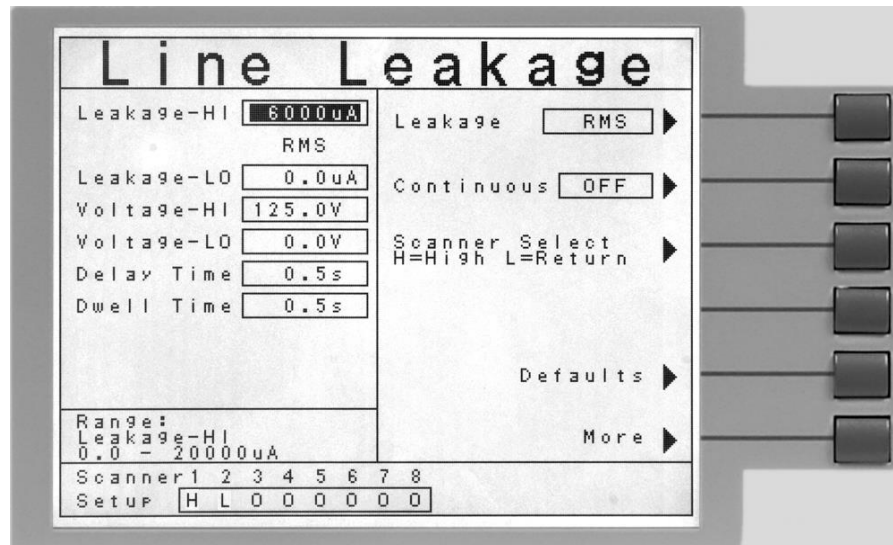

The operator may set the Scanner on a test-by-test basis. For example, for test step 01, the operator may set each of the Scanner channels in a particular configuration. For test step 02, the operator may wish to change the configuration of each Scanner channel.

#### 4.5.4. Run Test Function

To set up a Functional Run test, press the “Run Test” soft key from the Setup Tests screen. The Run Test Parameter Setting screen will now be displayed. The Run Test Parameter Setting screen will appear as follows:

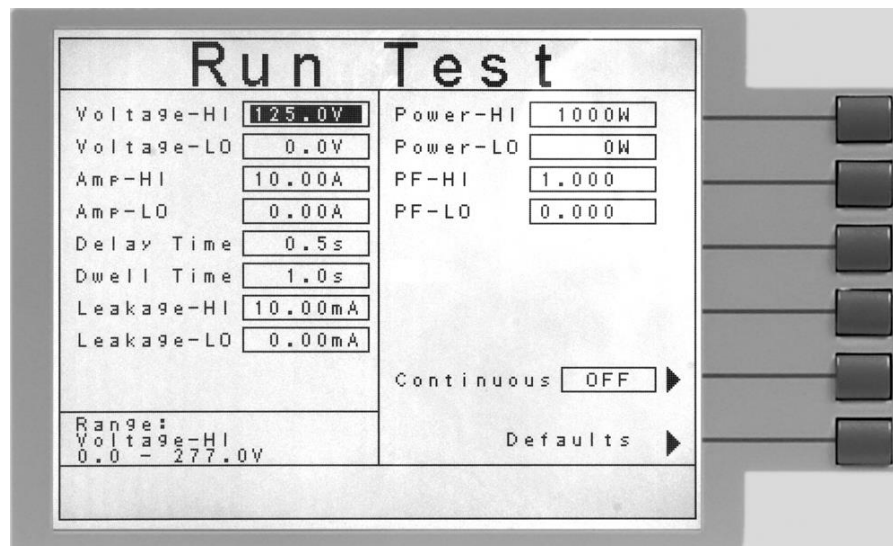

From the Run Test Parameter Setting screen the following parameters may be controlled: Voltage-HI, Voltage-LO, Amp-HI, Amp-LO, Delay Time, Dwell Time, Leakage-HI, Leakage-LO, Power-HI, Power-LO, PF-HI, PF-LO and Continuous. For

detailed descriptions of these parameters refer to section **4.4.1. Description of Test Parameters.**

- **Note:** Leakage in the Run Test mode refers to the amount of current which flows from the enclosure (case) of the DUT to the neutral side of the line input. The Leakage-HI trip limit is used to program the maximum allowable earth leakage current of the DUT before failure. The Leakage-LO trip limit is used to program the minimum allowable earth leakage current of the DUT before failure.

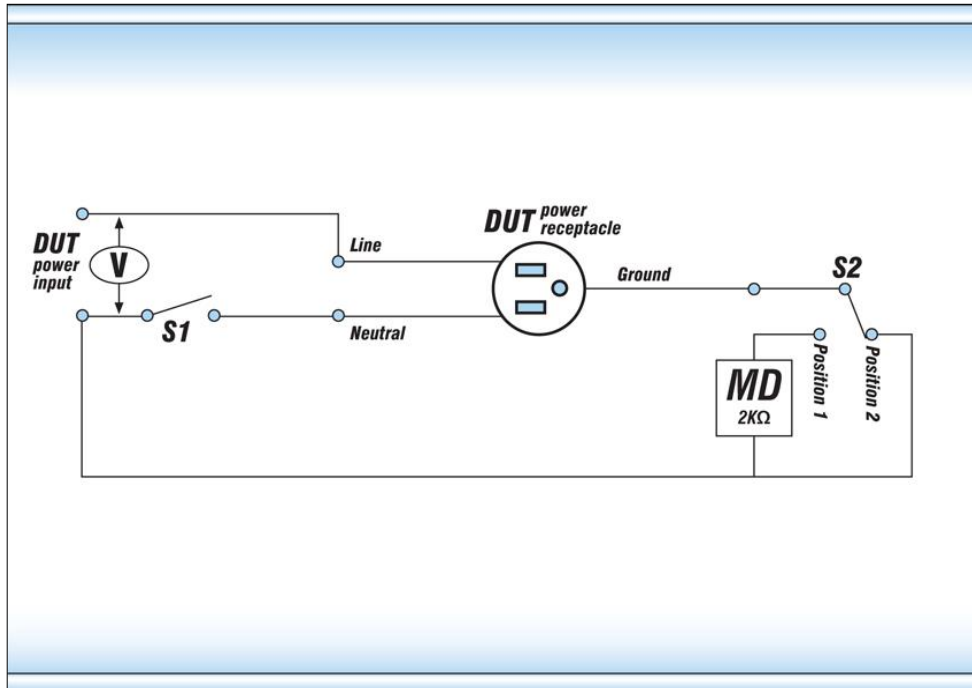

When the Leakage-HI trip limit is set to 0, S2 is placed in position 2 which disables the earth leakage test and connects the neutral of the DUT input to the ground of the DUT.

## 5. OPERATING INSTRUCTIONS

### 5.1. Instrument Connections

The 620L comes with all cables necessary to perform a Line Leakage test and a Functional Run test. Depending on the application, the test leads or adapter box may be connected to the receptacles located on the rear panel of the instrument.

#### 5.1.1. DUT Power Input Connections

These terminals provide the connections from an external power source to the 620L. The 620L will act as a “feed-through” by passing the DUT Power Inputs to the DUT Output terminals during a test.

In order to access the DUT Power Input Connections, you must remove the cover plate on the rear panel of the 620L. Once removed, you may use the black 10 AWG cables (included) to connect to a power source for applications up to and including 40 amps. These connections are terminated on one end and may be easily connected to the DUT Power Input screw-mount terminals. The opposite ends of the cables are left un-terminated so the operator may adjust the length and/or termination method.

An unbalanced single-phase power supply must be used with the 620L. This means that there is only one HOT or LINE conductor and the other conductor of the power source must be at a low voltage reference potential. The low voltage reference does not need to be physically earth grounded but should not carry any large voltage potential.

The 220 - 240V US style line power **IS NOT** suitable to connect to the DUT inputs. This style of power distribution is a balanced type with two HOT or LINE conductors.

#### **WARNING**

Be sure that the hot lead of the power source is connected to pin 1, L (line) terminal of the DUT Power Input terminal block and the return or low voltage lead is connected to pin 2, N (neutral) terminal of the DUT Power Input terminal block. **DO**

**NOT** connect a line conductor to the N or Neutral terminal of the DUT Power Input. This condition can be very dangerous to the operator.

If voltage is applied to pin 2, N (neutral) terminal of the DUT Power Input and you attempt to execute a Run Test or Line Leakage test, a warning message will appear in the displayed messages portion of the screen that says **Neutral-V**. If you see this message, you will need to correct the voltage problem before the instrument will allow you to execute Run Tests or Line Leakage tests.

### 5.1.2. Connecting the Test Leads

Included with the instrument are two black cables, each terminated with an alligator clip on one side. These cables are used to measure leakage current during either a Line Leakage test or a Functional Run test. Connect one or more of these cables to the Probe-HI and Probe-LO terminals on the rear panel of the 620L (the sense point is determined by the Line Leakage test Probe Configuration parameter, see section **4.5.2. Line Leakage Test** for more information). Connect the red test lead (also terminated in an alligator clip) to the GND terminal on the rear panel of the 620L. This will provide the return connection for all leakage current measurements. The alligator clips may be used to provide a connection to the necessary points on your DUT.

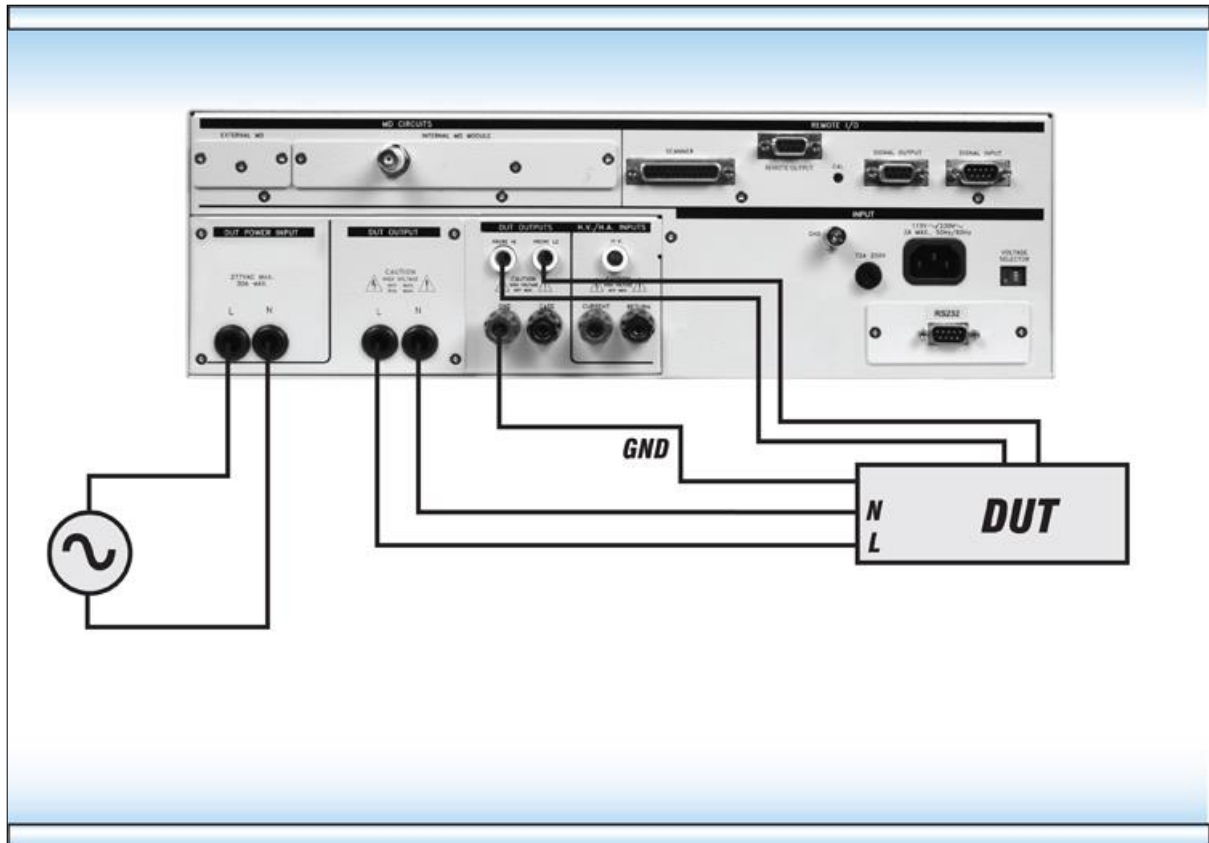

### 5.1.3. DUT Output Connections

These connections provide power to the DUT during a Line Leakage or Functional Run test. In order to access the DUT Output Connections, you must remove the cover plate on the rear panel of the 620L. Once removed, the set of black 10 AWG cables (included) may be used for the DUT Output connections for applications up to and including 40 amps. These cables are terminated on one end and may be easily connected to the DUT Output screw-mount terminals. The opposite ends of the cables are left un-terminated so the operator may adjust the length and/or termination method.

**WARNING**

These connections are live during testing. **Do not** come into contact with either the DUT Output Line or Neutral connections during a test, as this may present a serious shock hazard.

**5.1.4. Adapter Box Connections**

The adapter box may be used for products that are terminated in either a two prong or three prong line cord. Connect the adapter box to the DUT Output L (line) and N (neutral) terminals, and the GND terminal. The adaptor box will now provide power to the DUT during Line Leakage testing and Functional Run testing.

**CAUTION**

The adapter box may only be used for applications **under 20 amps**. If an application in which more than **20 amps** of input current is required, please use the stand-alone input and output cables provided with the instrument.

The following diagram shows how to connect the 620L to a DUT using the adapter box:

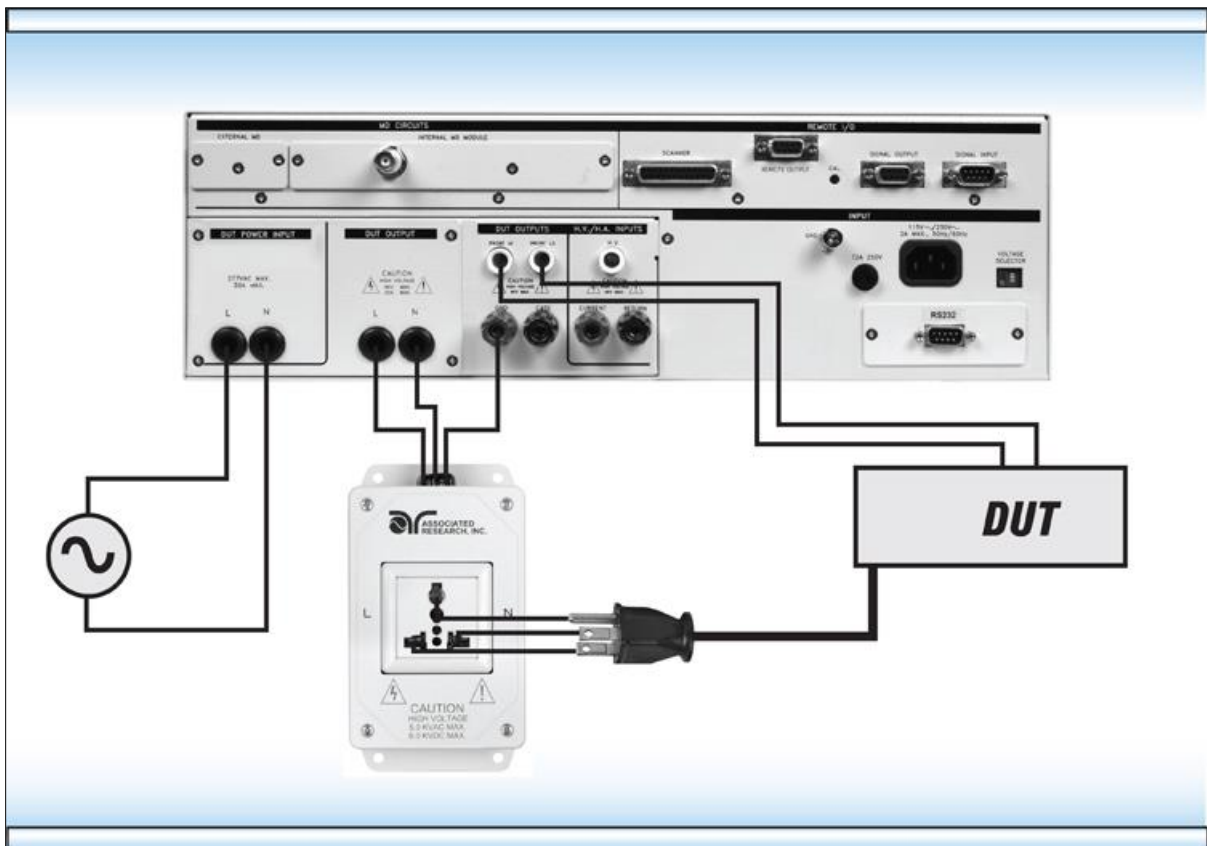

### 5.1.5. Interlock Connector

The 620L is equipped with a Remote Interlock feature. Remote Interlock utilizes a set of closed contacts to enable the instrument's output. If the Remote Interlock contacts are open the output of the instrument will be disabled. Remote Interlock can also be referred to as a remote system lockout, utilizing "fail when open" logic. To disable the Remote Interlock feature connect the Interlock Key into the Signal Input port located on the back of the tester. For more information refer to section **6.3. Remote Interlock**.



Remote Interlock Key

### 5.2. Perform Tests Menu

From the Main Menu screen press the "Perform Tests" soft key. The Perform Tests screen will now be displayed. From the Perform Tests screen, four different software controls may be accessed: Load File, Single Step (ON/OFF), Fail Stop (ON/OFF), Results. The arrow keys may also be used to scroll the highlighted area to a specific test or page of tests if the file is larger than 5 steps. The Perform Tests screen will appear as follows:

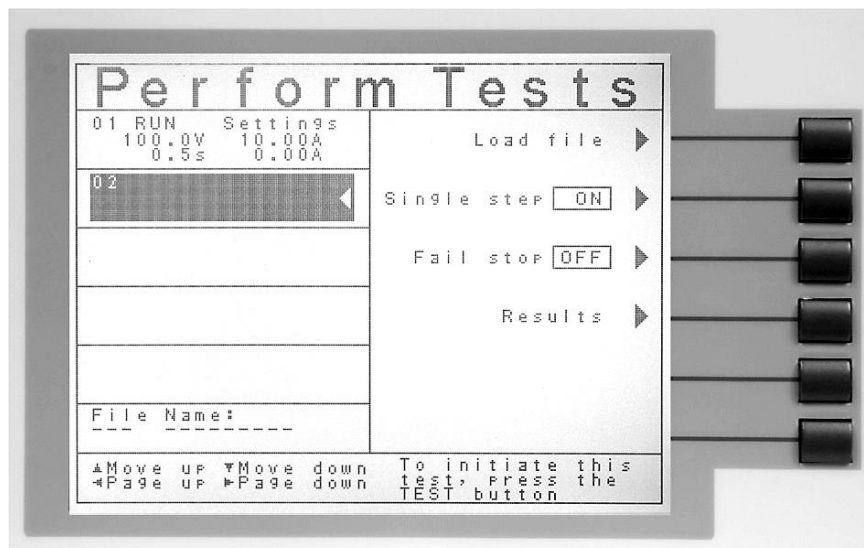

The Perform Tests screen is the main operational screen of instrument. From this screen individual steps are monitored while the test is being performed.

### 5.2.1. Load File

From the Perform Tests screen press the “Load File” soft key. The Load File screen will now be displayed. The Load File screen will appear as follows:

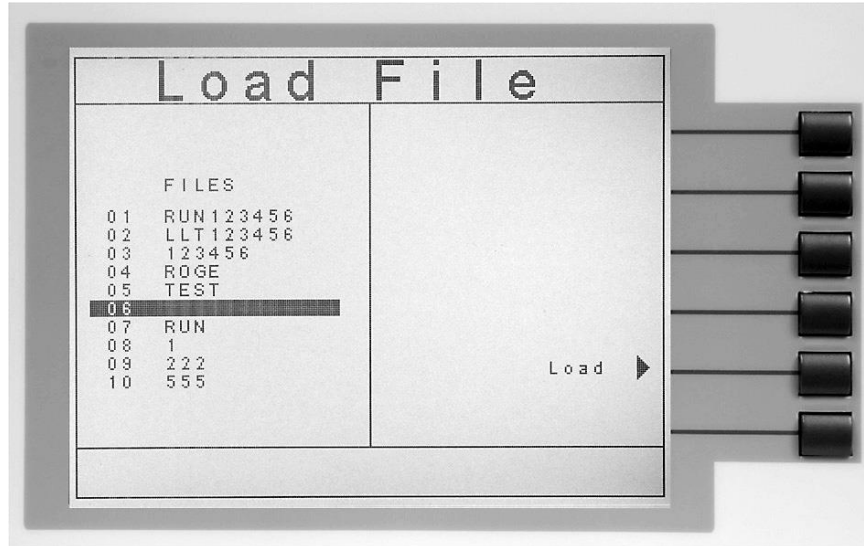

Using the up and down arrow keys, highlight the file you would like to load and press the “Load” soft key. The file you selected will now load and the screen will revert to the Perform Tests screen.

### 5.2.2. Single Step

Single step is a function that allows you to run one step at a time from a sequence of tests. At the Perform Tests screen use the up and down arrow keys or the ENTER key to scroll the highlighted area to the step you wish to perform. Press the TEST button and the instrument will initiate the single step and stop without continuing to the next step. If you press TEST again without first pressing RESET the next step will initiate, run to completion and stop. If a step fails and you wish to continue to the next step do not press RESET. After running a single step test a prompt will appear below the test file name telling you to press TEST button to continue. The prompt will appear as follows:

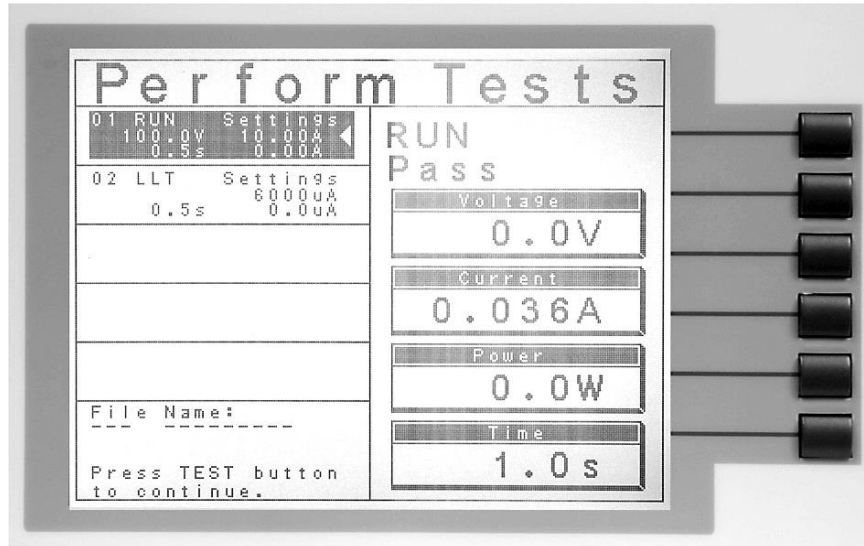

You may single step through an entire sequence in this way as long as you do not press RESET. Once RESET is pressed it will return you to the originally selected step.

Turn the Single Step function ON and OFF by pressing the “Single Step” soft key. If Security is enabled, Single Step may not be turned ON and OFF at the Perform Test screen. The state Single Step is in at the time security is enabled is the state at which it shall remain.

### 5.2.3. Fail Stop

Turns Fail Stop ON or OFF for the current test sequence. Altering this parameter will only affect tests that are run from this screen and will not be saved as part of the file’s parameters. If you wish to save the Fail Stop information you must edit the Fail Stop parameter in the Setup Tests screen. For more information on Fail Stop and the Setup Tests screen refer to section 4.3.6. **Fail Stop**.

### 5.2.4. Results

At the end of a test sequence or single step test you may review the measurements of each test by pressing the “Results” soft key. The Results screen will appear as follows:



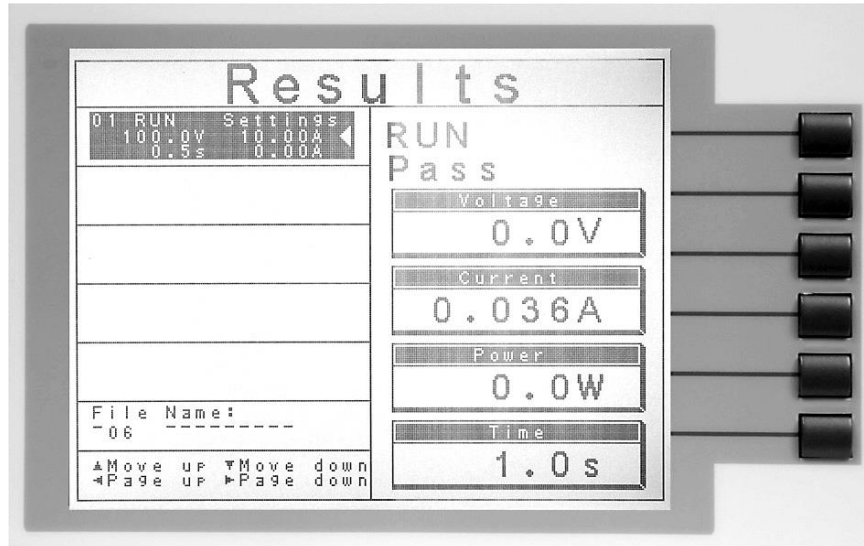

Using the up and down arrow keys scroll the highlighted area to the step results you wish to review. The left and right arrow keys may be used to page through results if the test contains more than five steps. When the highlighted area is on the step you are reviewing, the test settings will be displayed in the highlighted area and the results will appear on the right in the form of metering screens. The Result screens will appear differently for each type of test. The Results screens are based on the Perform Tests Metering screens and are identical in appearance except for the title. Refer to section **5.4. Perform Tests Metering** for the meters that will be displayed.

### 5.3. Performing a Test

1. As instructed in section **4.2. System Setup**, select a file and step that is suitable for the test you would like to perform.
2. Attach the appropriate DUT to the instrument (refer to section **5.1. Instrument Connections** for more information).
3. Press the TEST button.
4. The instrument will now perform the test or connected sequence of tests. If the test is started from any step other than 01 when you push RESET or TEST it will always return to the originally selected step.
5. If a Prompt is embedded within a step, the test will pause at that step and display the Prompt as a pop-up message. An example of a Prompt will appear as follows:

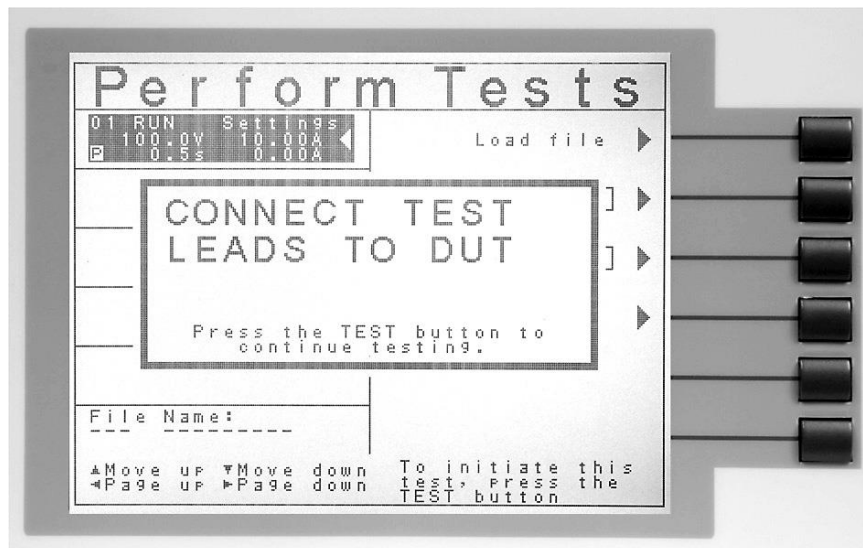

6. In order to clear the Prompt and continue the test, push the TEST button. The highlighted area of the screen remains on the test that is being performed until it is finished. On the right half of the screen the appropriate metering will display for the type of test that is being performed (refer to section **5.4. Perform Tests Metering** for more information). When the step is complete the highlighted area will sequence to the next step and the new metering display will appear (unless there is a prompt embedded within the step). When the highlighted area moves to the next step the previous step area will display the results of the test just performed.
7. At the end of the test sequence the right side of the screen will display a flashing PASS if all the tests have completed successfully. The screen will display a flashing FAIL if any of the tests did not complete successfully. If a test fails the right side of the screen will indicate the step that failed and which parameter of the step failed.

## 5.4. Perform Tests Metering

Each test performed by the 620L contains a unique set of parameters and therefore requires special metering for each test. The following table describes what meters will be displayed for each of the different test types.

METERING SCREENS FOR LINE LEAKAGE TEST		
VOLTAGE	CURRENT	TIME
X	X	X

METERING SCREENS FOR RUN TEST					
VOLTAGE	CURRENT	POWER	TIME	PF	LEAKAGE
X	X	X	X	X	X

### Alternate Metering

A Line Leakage test has a test parameter named Extended Meters that can be set ON or OFF. When the Extended Meters parameter is set to ON, the LCD display will show I-Maximum RMS and MD Voltage RMS. When Extended Meters is set to OFF, the standard Voltage RMA and Leakage Current RMS are displayed.

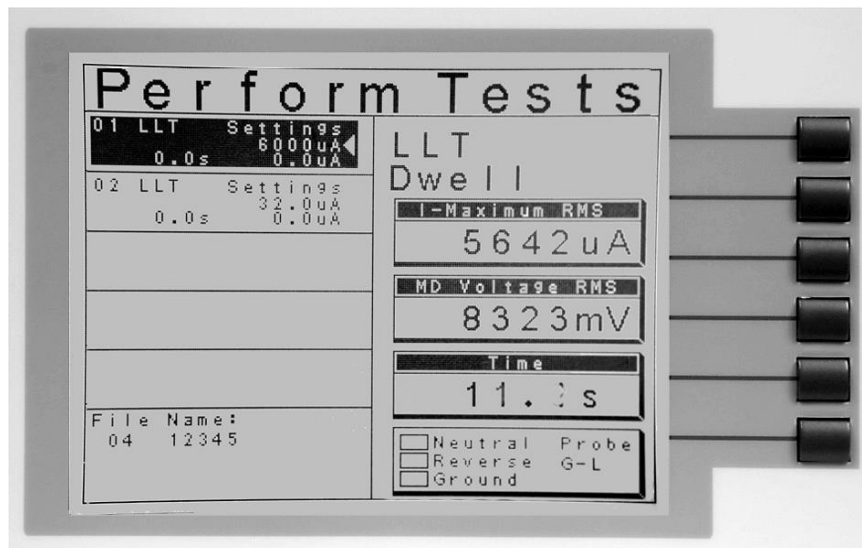

While a Run test is in the dwell phase you may view a series of alternate meters. The alternate meters are: leakage, PF, power and time.

While the test is running a Prompt will appear on the screen saying “To view alternate readings press the ENTER key.” The screen will appear as follows:

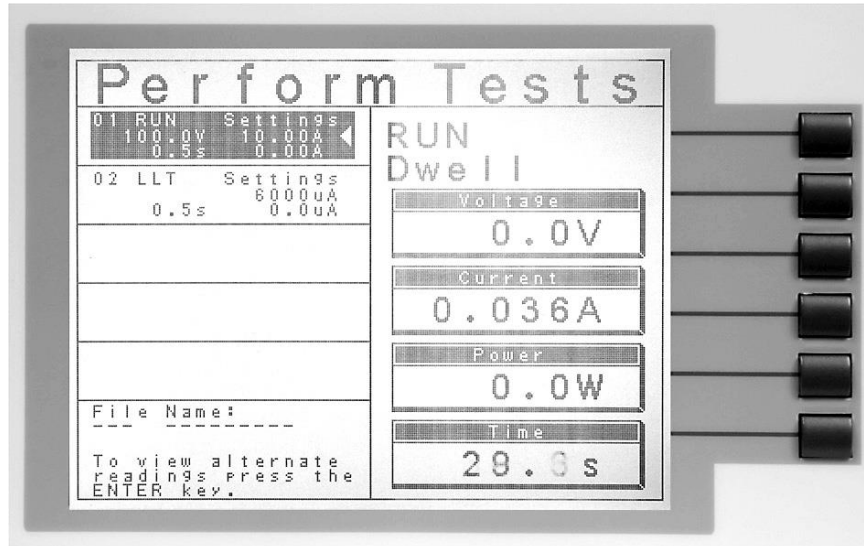

## 5.5. Displayed Messages

Directly above the Metering screens is the Test Status Display. This portion of the display is active during the test, allowing you to view the type of test being performed and status of the test step. At the end of a test the Test Status Display will either inform you that the test has passed or give a direct indication of the kind of failure that occurred during the test.

### 5.5.1. Test Status Messages

The following is a complete listing of the messages that appear in the Test Status Display and an explanation for each.

#### **Dwell**

This message appears on the display while a test is in process, the values update in real time.

#### **Delay**

This message appears on the display while a test is in process, the values update in real time.

#### **Pass**

This message appears on the display when the test process is complete and the DUT passed the test.

### 5.5.2. Error Messages

The following is a completing listing of the failure messages that may occur during testing and explanation for each.

#### **Volt-HI**

---

This message appears on the display if the DUT/IP voltage exceeds the Volt-HI Trip setting.

**Volt-LO**

This message appears on the display if the DUT/IP voltage drops below the Volt-LO Trip setting.

**Amp-HI**

This message appears on the display if the current exceeds the Amp-HI Trip setting

**Amp-LO**

This message appears on the display if the current drops below the Amp-LO Trip setting.

**Line-OC**

This message appears on the display if the 40 Amp < 1 s, short circuit protection is tripped.

**Watt-HI**

This message appears on the display if the DUT input wattage exceeds the Watt-HI Trip setting.

**Watt-LO**

This message appears on the display if the DUT input wattage drops below the Watt-LO Trip setting.

**PF-HI**

This message appears on the display if the Power Factor exceeds the PF-HI Trip setting.

**PF-LO**

This message appears on the display if the Power Factor drops below the PF-LO Trip setting.

**Leak-HI**

This message appears on the display if the enclosure to neutral leakage current exceeds the Leak-HI Trip setting.

**Leak-LO**

This message appears on the display if the enclosure to neutral leakage current drops below the Leak-LO Trip setting.

**Neutral-V**

This message appears on the display if there is voltage present on the Neutral of the DUT input receptacle.

**OTP**

This message appears on the display if the power transistors on the DUT Power Switch Board have overheated. When the OTP trips, the Calibration function will be disabled until the power transistors cool down.

### **Interlock Open**

This message appears on the display if the Remote Interlock feature is activated before or during a test. The Remote Interlock feature utilizes a set of closed contacts which will disable the instrument's output if they are opened before or during a test. Remote Interlock could also be referred to as a remote system lockout, utilizing "fail when open" logic. The Remote Interlock feature may be disabled by plugging the "Interlock Disable Key" provided into the Signal Input connector. See section **6.2. Remote Signal Inputs and Memory Access** for more information.

## Fatal Error

If the instrument has a recognizable internal component failure and the TEST button is pressed, the Fatal Error screen will appear as follows:

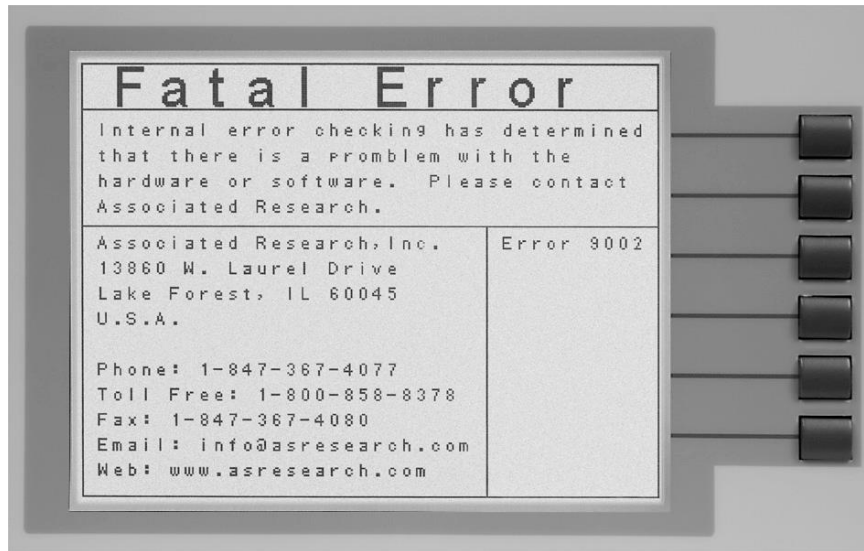

This type of failure permanently locks the instrument in the “Fatal Error” mode and requires that the instrument be serviced by Associated Research, Inc. The following Fatal Error identification numbers will represent the type of failure that has occurred:

**Error Code 9001** will appear on the display if the instrument has a recognizable internal component failure.

**Error Code 9002** will appear on the display if the instrument’s System Data or the Model/Option/Serial Number Data are corrupted and do not match the settings.

**Error Code 9003** will appear on the display if the instrument’s Calibration Data is corrupted.

## 6. CONNECTION OF REMOTE I/O

Two 9-pin “D” type connectors mounted on the rear panel provide REMOTE-INPUT-OUTPUT control and information. These connectors mate with a standard 9 pin D-sub-miniature connector provided by the user. The output mates to a male (plug) connector while the input mates to a female (receptacle) connector. For best performance, a shielded cable should be used. To avoid ground loops the shield should not be grounded at both ends of the cable. Suggested AMP part numbers for interconnecting to the Remote I/O are shown below:

205204-4	PLUG SHELL WITH GROUND INDENTS
205203-3	RECEPTACLE SHELL
745254-7	CRIMP SNAP-IN PIN CONTACT (for plug)
745253-7	CRIMP SNAP-IN SOCKET CONTACT (for receptacle)
745171-1	SHIELDED CABLE CLAMP (for either plug or receptacle)
747784-3	JACKSCREW SET (2)

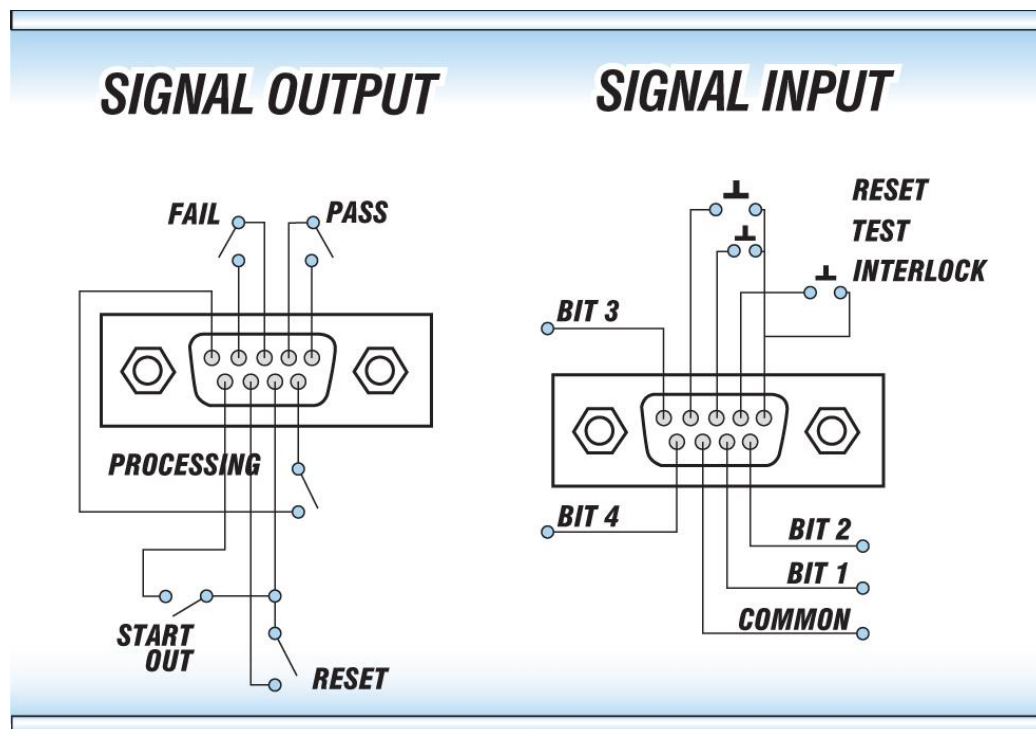

### 6.1. Remote Signal Outputs

The rear panel connector provides three output signals to remotely monitor PASS, FAIL, and PROCESSING conditions. The monitoring signals are provided by three normally open internal relays that toggle ON and OFF to indicate the condition of the tester. These are normally open free contacts and will not provide any voltage or current. The ratings of the contacts are 1 AAC / 125 VAC (0.5 ADC / 30 VDC). The signal outputs are provided on the 9-pin female “D” type connector. Below is a list that



indicates what conditions activate each pin. When a terminal becomes active the relay closes thereby allowing the external voltage to operate an external device:

Pins 1 and 2 provide the PASS signal.  
Pins 3 and 4 provide the FAIL signal.  
Pins 5 and 6 provide the PROCESSING signal.  
Pins 7 and 8 provide the RESET signal.  
Pins 7 and 9 provide the START OUT signal.

The following describes how the relays operate for each test condition:

**PASS** – The relay contact closes the connection between pin (1) and pin (2) after detecting that the item under test passed all tests. The connection is opened when the next test is initiated or the reset function is activated.

**FAIL** – The relay contact closes the connection between pin (3) and pin (4) after detecting that the item under test failed. The connection will open when the next test is initiated or the reset function activated.

**PROCESSING** – The relay contact closes the connection between pin (5) and pin (6) while the instrument is performing a test. The connection is opened at the end of the test.

**RESET OUT** – The relay contact closes the connection between pin (7) and pin (8) while the reset function is activated. This is only a continuous closure dependent on the length of time the reset button is held in an active state.

**START OUT** – The relay contact closes the connection between pin (7) and pin (9) after a test sequence has completed and passed. This is a momentary relay closure and may be used to initiate a Hipot or Ground Bond test from another Associated Research, Inc. instrument.

## **6.2. Remote Signal Inputs and Memory Access**

The 620L remote connector enables remote operation of the TEST, RESET, and REMOTE INTERLOCK functions, and allows the operator to select one of 10 pre-programmed test files.

When the PLC Remote mode is on, the 620L will respond to simple switch or relay contacts closures. A normally open momentary switch can be wired across pins 3 and 5 to allow remote operation of the TEST function. A minimum pulse width or contact closure of 20mS is required to guarantee a test start. A normally open momentary switch can be wired across pins 2 and 5 to allow remote operation of the RESET function. A minimum pulse width or contact closure of 50mS is required to guarantee that a running test will abort. When the PLC remote function is (ON) the TEST switch on the front panel will be disabled to prevent a test from being activated through this switch. For safety, the front panel RESET switch remains active even when a remote reset switch is connected so that high voltage can be shut down from either location.

DID YOU KNOW?
The Remote Signal Input connector may be used with various accessories, including light curtains, foot switches, and safety probes. Contact Associated Research, Inc. for more information.

The Remote File Select function gives the user the capability to quickly change parameters and initiate a test remotely. Ten pre-programmed test files can be accessed by connecting pins 1,6,8, and 9 to the common pin 7, in different combinations. The memory select bits should be set simultaneously and remain set for a minimum of 20ms to guarantee that the correct memory will be selected. However, the memory select bits may be set in sequential manner, provided that the time delay between each bit is less than 4ms. When the desired bit pattern has been established it should remain set for a minimum of 20ms to guarantee that the correct memory will be selected. The **Remote File Select Truth Table** (binary) shows the different combinations of momentary switch (relay) closures, and which memory programs that will be selected as the result. It may be necessary to "OR" the momentary switches (relay contacts) to prevent incorrect program selection due to timing errors.

REMOTE FILE SELECT TRUTH TABLE				
BIT 4	BIT 3	BIT 2	BIT 1	FILE #
0	0	0	1	01
0	0	1	0	02
0	0	1	1	03
0	1	0	0	04
0	1	0	1	05
0	1	1	0	06
0	1	1	1	07
1	0	0	0	08
1	0	0	1	09
1	0	1	0	10
1= Momentary Contact closure between BIT and COMMON				
0= No Contact closure between BIT and COMMON				

**WARNING**

ACTIVATING MEMORY PROGRAM FUNCTIONS THROUGH THE REMOTE CONNECTOR, SELECTS THE PROGRAM AND STARTS THE TEST WHICH IS PREPROGRAMMED INTO THAT MEMORY.

**CAUTION**

DO NOT CONNECT VOLTAGE OR CURRENT TO THE SIGNAL INPUTS, THIS COULD RESULT IN DAMAGE TO THE CONTROL CIRCUITRY.

### 6.3. Remote Interlock

The 620L is equipped with a Remote Interlock feature. Remote Interlock utilizes a set of closed contacts to enable the instrument's output. If the Remote Interlock contacts are open the output of the instrument will be disabled. Remote Interlock could also be referred to as a remote system lockout, utilizing "fail when open" logic. If the Remote Interlock contacts are open and the TEST button is pushed, a pop-up message will be displayed on the screen for two seconds. The message will appear as follows:

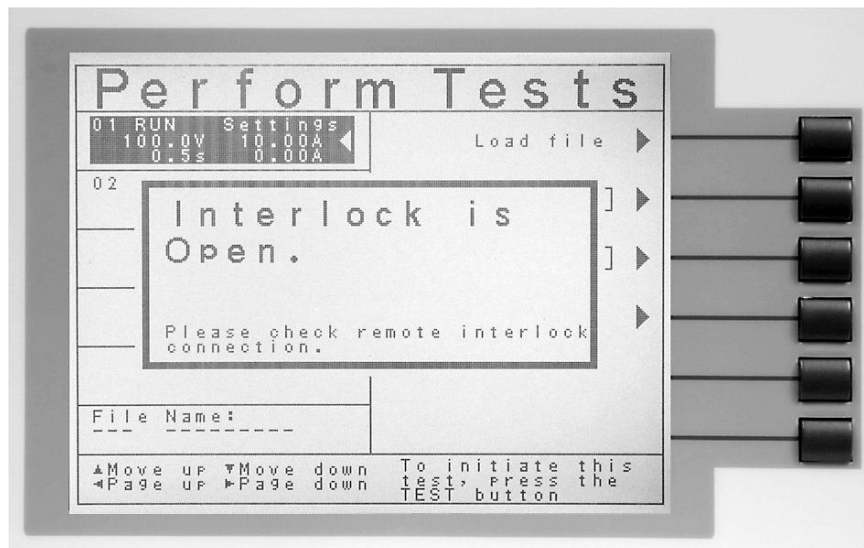

If the Remote Interlock contacts are opened during a test, the pop-up message will be displayed and the test will abort. The hardware has been configured to provide the interlock connections on pins 4 and 5 of the Remote Interface, Signal Input port. The instrument can still be used without the external interlock device as long as the Interlock Disable Key (p/n 38075 provided with unit) is plugged into the Remote Interface, Signal Input port. If there is nothing connected to the Remote Interface, Signal Input port to provide a connection to the Remote Interlock, the instrument will not perform tests.



Remote Interlock Key

## 7. BUS REMOTE INTERFACE GPIB/ USB/RS-232

This section provides information on the proper use and configuration of the bus remote interface. The USB/RS-232 remote interface is standard on the 620L but the GPIB (IEEE-488) interface option can be substituted for the USB/RS-232 interface. Please refer to section **8.0. Options** for details on the 620L options.

The USB/RS-232 interface card requires the user to download a driver in order for the instrument to recognize the USB interface. The driver can be found on the Associated Research, Inc. website:

<https://www.ikonixusa.com/support/instrument-drivers>

Click on “USB/RS-232 Driver” to download the driver. This link contains an automatic extract and install program. Follow the instructions of the installation program to initialize the driver install. NOTE: The USB port acts as a USB to RS-232 converter. As a result, the PC will recognize the USB port as a virtual COM port.

The USB/RS-232 interface uses the same command set as the GPIB interface for setting test parameters; however, many functions of the GPIB 488.2 interface are not available through USB/RS-232. The IEEE-488 interface included with the 620L conforms to the requirements of the IEEE-488.2 standard.

### 7.1. USB/RS-232 Interface

This interface provides all of the control commands and parameter setting commands of the GPIB interface with the exception of some of the 488.2 Common Commands and SRQ capability. All commands can be found in section **7.4. USB/RS-232/GPIB Command List**. The identification command \*IDN and the Status Reporting commands are also available through USB/RS-232.

#### 7.1.1. USB/RS-232 Connector

The USB/RS-232 cabling should be configured as follows for a 9-pin serial port interface:

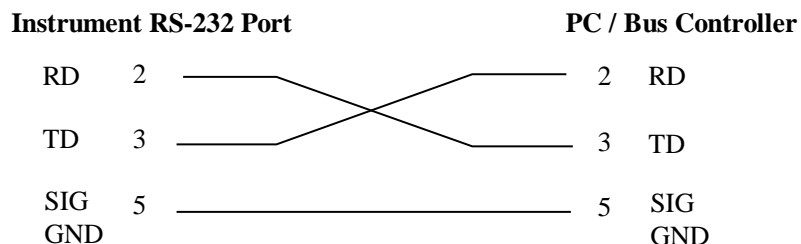

### 7.1.2. Communications Port Configuration

The COM port should have the following configuration:

- 9600 baud
- 8 data bits
- 1 stop bit
- No parity

This interface does not support XON/XOFF protocol or any hardware handshaking. The controller should be configured to ignore the handshaking lines DTR (pin 4), DSR (pin 6) CTS (pin 8) and RTS (pin 7). If the port cannot be configured through software to ignore these lines the handshake lines should be jumpered together in two different sets. Pins 4 and 6 should be jumpered together and pins 7 and 8 should be jumpered together at the controller end of the cable.

### 7.1.3. Sending and Receiving Commands

#### Sending Data

Once a command is sent to the instrument over the USB/RS-232 bus the instrument will send one of two responses. If the transfer was recognized and completed the instrument will return with 06 hex or 6 decimal, the Acknowledge (ACK) ASCII control code. If there is an error with the command string that is sent, the instrument will respond with 15 hex or 21 decimal, the Not Acknowledge (NAK) ASCII control code. The ACK or NAK response allows for software handshaking to monitor and control data flow.

#### Receiving Data

When requesting data from the instrument it will automatically send the data back to the controller input buffer. The controller input buffer will accumulate data being sent from the instrument, including the ACK and NAK response strings, until it has been read by the controller.

## 7.2. GPIB Interface

This interface is optional on the 620L and provides all of the control commands and parameter setting commands of the USB/RS-232 interface along with 488.2 Common Commands and SRQ capability. All commands can be found in section **7.4. USB/RS-232/GPIB Command List**.

### 7.2.1. GPIB Connector

Connection is usually accomplished with a 24-conductor cable with a plug on one end and a connector at the other end. Devices may be connected in a linear, star or a combination configuration.

The standard connector is the Amphenol or Cinch Series 57 Microribbon or AMP CHAMP type. The GPIB uses negative logic with standard transistor-transistor logic (TTL) levels. When DAV is true, for example, it is a TTL low level ( $\leq 0.8$  V), and when DAV is false, it is a TTL high level ( $\geq 2.0$  V).

#### Restrictions and Limitations on the GPIB

- A maximum separation of 4 m between any two devices and an average separation of 2 m over the entire bus.
- A maximum total cable length of 20 m.
- No more than 15 device loads connected to each bus, with no less than two-thirds powered on. For example 1 GPIB controller and a maximum of 14 GPIB instruments.
  
- **Note:** A bus extender, which is available from numerous manufacturers, is available to overcome these limitations.

### 7.2.2. GPIB Address

Each device on the GPIB (IEEE-488) interface must have a unique address. You can set the address of the 620L to any value between 0 and 30. The address can only be set from the front panel. The address is stored in non-volatile memory and does not change when the power has been off or after a remote reset.

- **The address is set to 9 when the instrument is shipped from the factory.**

## 7.3. Interface Functions

The capability of a device connected to the bus is specified by its interface functions. These functions provide the means for a device to receive, process, and send messages over the bus. The interface functions are listed in the chart below.

### GPIB 488.1 INTERFACE FUNCTIONS

INTERFACE FUNCTION	SUBSET	DESCRIPTION
Source Handshake	SH1	Complete Source handshake capability
Acceptor Handshake	AH1	Complete Acceptor handshake capability
Talker	T6	Talker functions (unaddress if MLA)
Listener	L4	Listener functions (unaddress if MTA)
Service Request	SR1	Complete Service request capability
Remote Local	RL0	No remote/local capability
Parallel Poll	PP0	No parallel poll capability
Device Clear	DC1	Complete Device clear capability
Device Trigger	DT0	No device trigger capability
Controller	C0	No controller capability
Electrical Interface	E2	Three-state drivers

Controllable Items	Test and Reset control. Setting of test parameters for tests. Reading of instrument status and test results.
Data Codes	ASCII
Delimiter	NL (+ EOI)

## 7.4. USB/RS-232 / GPIB Interface Command List

### 7.4.1. Echo and Response Considerations

#### USB/RS-232 Responses

The USB/RS-232 bus will automatically send any response back to the controller's input buffer.



## GPIB Queries and Responses

The 620L GPIB bus will not send any data to the controller without being queried. A GPIB read command must be sent after a command string to retrieve any data from a query command (?).

### Rules for Sending Commands to the Instrument

The following conventions are used to describe the commands syntax for the 620L:

- Braces ( { } ) enclose each parameter for a command string.
- Triangle brackets ( < > ) indicate that you must substitute a value for the enclosed parameter.
- The Pipe ( | ) is used to separate different parameter options for a command.
- The command and the parameter data must be separated with a space.
- Each command string should be terminated by the ASCII control code, New Line (NL), (OAh) or the end of line (EOL) message for GPIB.
- All commands that end with a question mark (?) are query commands and required an IEEE-488 read command to retrieve the data from the device's output buffer.

#### 7.4.2. Test Execution Commands

The following commands are used to control actual output voltage and current from the instrument. Please observe all safety precautions.

COMMAND	DESCRIPTION
TEST	Execute a Test
RESET	Abort a test in Process or Reset Failures

#### TEST

Starts the test sequence at the selected step loaded into memory (RAM).

#### RESET

Stop or abort a test. Also used to reset a latched failure condition.

#### 7.4.3. File Editing Commands

The following commands are used to create or modify Test Setup Files.

- Commands should be separated from parameters by a space.
- If multiple parameters are entered, they should be separated by commas.

COMMAND	DESCRIPTION	VALUE
FL <file number>	File Load	file number = 1-50
FD	File Delete	Active selected File
FD <file number>	File Delete by Number	file number = 1-50
FS	File Save	Active selected File
FSA {<file number>,<file name>}	File Save-as	file number = 1-50, file name = Valid ASCII (1) maximum 11 characters
FM {1 0}	File Memory Link	1=On, 0=Off
FM?		
FN {<file number>,<file name>}	File New	file number = 1-50, file name = Valid ASCII (1) maximum 11 characters
SS <step number>	Step Select	step number = 1-30
ADD <test,p1,p2,p3...>	Adds all parameters	
SAR	Step Add RUN test	
SAL	Step Add LLT test	
SD	Step Delete	Active selected Step
SD <step number>	Step Delete by Number	step number = 1-30
SP <prompt message>	Step Prompt Create	prompt message = Valid ASCII (1) maximum 32 characters
SP	Step Prompt Delete	
SF {1 0}	Step Fail Stop	1=On, 0=Off

(1) "Valid ASCII" is the character set that is available from the front panel LCD user interface. Consisting of upper case alphabet (A-Z), numbers (0-9) and decimal point (.), asterisk (\*), dash (-), under bar (\_), tilde (~) and space (SP).

#### **FL <memory number>**

Load a file by memory number from non-volatile memory into random access memory RAM.

#### **FD**

Deletes the file loaded into RAM from the non-volatile memory space as well as RAM. A new file must be loaded before and tests can be run.

### **CAUTION**

The "FD" command writes to the non-volatile memory of the instrument. The non-volatile memory has a limited write cycle life. Therefore, for programmers who wish to send all parameters before executing each test, the "FD" command should not be used.

Refer to section **7.5, Non Volatile Memory** for more information.

**FD <file number>**

Deletes a file from non-volatile memory indicated by the file number.

**CAUTION**

The “FD” command writes to the non-volatile memory of the instrument. The non-volatile memory has a limited write cycle life. Therefore, for programmers who wish to send all parameters before executing each test, the “FD” command should not be used.

Refer to section **7.5, Non Volatile Memory** for more information.

**FS**

Saves the file from RAM to the non-volatile memory space.

**CAUTION**

The “FS” command writes to the non-volatile memory of the instrument. The non-volatile memory has a limited write cycle life. Therefore, for programmers who wish to send all parameters before executing each test, the “FS” command should not be used.

Refer to section **7.5, Non Volatile Memory** for more information.

**FSA {<file number>,<file name>}**

Saves the current file from RAM into the non-volatile memory space with the indicated file number and file name. The original file will not be modified with this operation. If there is a file already located at the desired number it will be moved to the next higher number and inserted in its place. New files may be added to the bottom of the file list but there must not be any numbers that do not have a file defined.

**CAUTION**

The “FSA” command writes to the non-volatile memory of the instrument. The non-volatile memory has a limited write cycle life. Therefore, for programmers who wish to send all parameters before executing each test, the “FSA” command should not be used.

Refer to section **7.5, Non Volatile Memory** for more information.

**FM**

Links the last test step of a 30 step memory location to step 1 of the following memory location.

**FN < file name>**

Creates a new file name for the active memory loaded into RAM.

**CAUTION**

The “FN” command writes to the non-volatile memory of the instrument. The non-volatile memory has a limited write cycle life. Therefore, for programmers who wish to send all parameters before executing each test, the “FN” command should not be used.

Refer to section **7.5, Non Volatile Memory** for more information.

**SS <step number>**

Selects the active selected step to load into RAM. The step must first be selected before any specific parameters can be edited.

**ADD <test p1,p2,p3...>**

This command edits all parameters in a step. Parameters will be edited at the step location that has been selected. See the command summary tables below to see the specific test type for each of these commands

The parameter *<test>* indicates the test type. The values LLT and RUN must be used. The parameters *<p1,p2>* etc. indicate the individual settings for each parameter of the test. All parameters must be included with the command and should appear in the same order that is shown in the table below. Also, like the individual parameter editing commands, the unit should not be included with the value; only the numeric value should be included in the command string. When the scanners are being used they should be appended to the end of the string.

The list of parameters can also be found in the default parameters section of the manual, or refer to **Section 7.4.2. Test Parameter Editing Commands and Companion Queries** for the proper values.

The parameter values for file editing commands should use complete text (i.e. "ON" and "OFF") and not use the coded values that are associated with the test parameter setting commands discussed in **Section 7.4.2. Test Parameter Editing Commands and Companion Queries**. The LS? companion command will also list all parameters in complete text in the order as they appear in the following table, preceded by the step number.

	<b>RUN</b>	<b>LLT</b>
<b>1</b>	Voltage-HI	Leakage-HI
<b>2</b>	Voltage-LO	Leakage-LO
<b>3</b>	Amp-HI	Voltage-HI
<b>4</b>	Amp-LO	Voltage-LO
<b>5</b>	Dwell Time	Delay Time
<b>6</b>	Delay Time	Neutral ( <i>OPEN/CLOSED</i> )
<b>7</b>	Leakage-HI	Reverse ( <i>ON/OFF</i> )
<b>8</b>	Leakage-LO	Ground ( <i>OPEN/CLOSED</i> )
<b>9</b>	Power-HI	Meas. Device ( <i>UL544NP/UL544P/IEC60601 UL2601/UL1563/IEC60990 FIG4- U2, IEC62368/IEC60990 FIG5- U3/EXTERNAL</i> )
<b>10</b>	Power-LO	Probe ( <i>Ground To Line/ Probe-HI to Line/Probe-HI To Probe-LO</i> )
<b>11</b>	PF-HI	Leakage Mode ( <i>Peak/RMS</i> )
<b>12</b>	PF-LO	Extended Meter ( <i>ON/OFF</i> )
<b>13</b>	Continuous ( <i>ON/OFF</i> )	AC/DC ( <i>AC+DC,AC,DC</i> )
<b>14</b>		Ranging Mode ( <i>AUTO, MANUAL</i> )
<b>15</b>		Continuous ( <i>ON/OFF</i> )
<b>16</b>		Scanner

### **SAR, SAL**

These commands insert or add a new step to the test sequence. This command will add or insert the test at the step location that has been selected. When a test has already been created at a selected step then the new step will be inserted and the previous step will move down to the next step and all other step will be renumbered accordingly. See the command summary tables to see the specific test type for each of these commands.

### **SD**

Deletes the active step from the setup file sequence. All step after this step will move up and be renumbered accordingly.

### **SD <step number>**

Deletes the step indicated by the number from the setup file sequence. All step after this step will move up and be renumbered accordingly.

### **SP <prompt message>**

Adds or edits a prompt message for the active step.

### **SP**

Removes or deletes the prompt that had been created for the active step.

**SF {1|0}**

Sets the Fail Stop function OFF or ON for the active setup file loaded into RAM. 1 sets the Fail Stop = ON, 0 sets the Fail Stop = OFF.

#### 7.4.4. Test Parameter Editing Commands and Companion Queries

These commands are used to modify the test parameter within each step. These commands require a parameter value to be included with the command. The companion query command will read the parameter. The writing of the parameter requires that the unit not be included with the value, only the numeric value should be included with the command. Also, when the query commands are used the response will not include the unit's characters. Many of the commands will function the same way for multiple test types; however, the input range may be different and therefore used a different possible set of values.

COMMAND	NAME	TEST TYPES	VALUE
EACDC {0 1 2} EACDC?	Edit AC/DC Mode	LLT	0=ACDC, 1=AC, 2=DC
ECH < value > ECH?	Edit Current-HI	RUN	0.00 - 15.00A
ECL < value > ECL?	Edit Current-Lo	RUN	0.00 - 15.00A
ECTN {1 0} ECTN?	Edit Continuous Power	LLT RUN	1=On, 0=Off
EDE < value > EDE?	Edit Delay	RUN LLT	0.0 - 999.9s
EDW < value > EDW?	Edit Dwell	RUN	0.0 - 999.9s
EEM {1 0} EEM?	Edit Extended Meter	LLT	1=On, 0=Off
EG {1 0} EG?	Edit Ground	LLT	1=Open, 0=Close
ELH < value > ELH?	Edit Leakage-HI	RUN	0.000 - 10.00mA
ELL < value > ELL?	Edit Leakage-LO	RUN	0.000 - 10.00mA
ELM {1 0} ELM?	Edit Leakage Mode	LLT	1=Peak, 0=RMS
EM {0 1 2 3 4 6 8 9} EM?	Edit Meas-Device	LLT	0=UL544NP 1=UL544P 2=IEC60601, UL2601 3=UL1563 4=IEC60990 FIG4-U2, IEC 62368 6=IEC60990 FIG5-U3 8=External 9=Frequency Check
EN {1 0} EN?	Edit Neutral	LLT	1=Open, 0=Close
EPFH < value > EPFH?	Edit PF-HI	RUN	0.000 - 1.000

EPFL < value > EPFL?	Edit PF-LO	RUN	0.000 - 1.000
EPOH < value > EPOH?	Edit Power-HI	RUN	0 - 4200W
EPOL < value > EPOL?	Edit Power-LO	RUN	0 - 4200W
EP {0 1 2} EP?	Edit Probe	LLT	0=Ground to Line 1=Probe-HI to Line 2=Probe-HI to Probe-LO
ER {1 0} ER?	Edit Reverse	LLT	1= On, 0=Off
ERM {1 0} ERM?	Edit Ranging Mode	LLT	0=Manual 1=Auto
ES <scanner string> ES?	Edit Scanner High Voltage Multi-port	LLT RUN	scanner string = 1-16 element ASCII string consisting of H, L, or O. H=HV, L=RETURN, O=OPEN
EVH < value > EVH?	Edit Voltage-Hi	RUN LLT	0.0 - 277.0V
EVL < value > EVL?	Edit Voltage-Lo	RUN LLT	0.0 - 277.0V

#### 7.4.5. System Parameter Editing Commands and Companion Queries

These commands are used to modify the system parameters for the instrument.

These commands require a parameter value to be included with the command. The companion query command will read the parameter using the same value that is used for setting the parameter.



COMMAND	NAME	VALUE
SA < value > SA?	Alert Date	mm,dd,yy or yy,mm,dd or dd,mm,yy ; same as SDF setting
SAL < value > SAL?	Alarm Volume	0-9
SC < value > SC?	Contrast	1-9
SCA {1 0} SCA?	Cal Alert	1= On, 0=Off
SCDA < value > SCDA?	Cal Date	mm,dd,yy or yy,mm,dd or dd,mm,yy ; same as SDF setting
SCDU < value > SCDU?	Cal Due	mm,dd,yy or yy,mm,dd or dd,mm,yy ; same as SDF setting
SDAY {6 5 4 3 2 1 0} SDAY?	Day of the week	0,1,2,3,4,5,6= Sun,M,T,W,T,F,Sat
SDF < value > SDF?	Date Format	0=yy,mm,dd, 1=mm,dd,yy 2=dd,mm,yy
SDT < value > SDT?	Date	mm,dd,yy or yy,mm,dd or dd,mm,yy ; same as SDF setting
SL {1 0} SL?	Lock	1= On, 0=Off
SML {1 0} SML?	Memory Lock	1= On, 0=Off
SMM {1 0} SMM?	Main Menu page	1= On, 0=Off
SOI {1 0} SOI?	620L Info page	1= Pause, 0=Continue
SPR {1 0} SPR?	PLC Remote	1= On, 0=Off
SSI {1 0} SSI?	Single Step	1= On, 0=Off
STM < value > STM?	Time	hh,mm (24hr) hh,mm,AM or hh,mm,PM (12hr) according to STF setting
STF {1 0} STF?	Time Format	0=12hr, 1=24hr
SV{1 0} SV?	Verification page	1= On, 0=Off

#### 7.4.6. Query Commands

These query commands will retrieve data from the instrument. The GPIB bus application requires an IEEE-488 read command to be sent after the query command. These commands include functions for retrieving test data, test results and remote hardware status as well as setup file information.

COMMAND	NAME	VALUE
TD?	List Testing Data	Test In Process
RD <step number>?	List Results Data	<i>step number</i> = 1-30
RD <file number>, <step number>?	List Results Data with Memory Link active	<i>file number</i> = 1-50 <i>step number</i> = 1-30
RR?	Read Remote Reset	1=Open, 0=Closed
RI?	Read Remote Interlock	1=Open, 0=Closed
RS?	Read Scanner Status	0 = None, 1 = Internal 2 = External, 3 = Both
LF?	List File Name	Active selected memory
LFN?	List Memory (File) Number	Active selected memory
LF <memory number>?	List File Name by memory number	<i>memory number</i> = 1-50
LP?	List Prompt	Active selected Step
LP <step number>?	List Prompt by step number	<i>step number</i> = 1-30
LS?	List Step Parameters	
LS <step number>?	List Step Parameters by step number	<i>step number</i> = 1-30
SS?	List Selected Step	<i>step number</i> = 1-30
SF?	List Fail Stop condition	1=On, 0=Off

### TD?

Read the active data being displayed on the LCD display while the test is in process. Will also read the last data taken when the test sequence has completed. Each parameter is separated by commas and includes step number, test type, test status, and metering. The syntax for this command response is {step, test type, status, meter 1, meter 2, meter 3}. Each meter will contain only the value and not the units.

### RD <step number>?

Read the results for an individual step. The step number is the actual step number that has been saved within the file, not the order of which the steps were executed. For example if the test was executed starting from step 3 and ending with step 5 then the first step test results will be found in location 3 not in location 1. Each parameter is separated by commas and includes step number, test type, test status, and metering. The syntax for this command response is {step, test type, status, meter 1, meter 2, meter 3}. Each meter will contain only the value and not the units.

### RD <file number>, <step number>?

Read the results for an individual step when multiple files are linked. The file number is the actual location to which the file has been saved. The step number is the actual step number that has been saved within the file, not the order of which the steps were executed. For example if the test was executed starting from step 3 and ending with step 5 then the first step test results will be found in location 3 not in location 1. Each parameter is separated by commas and includes step number, test type, test status,

and metering. The syntax for this command response is {step, test type, status, meter 1, meter 2, meter 3}. Each meter will contain only the value and not the units.

**RR?**

Read the remote Reset input signal. When the remote reset has been activated by closing the contacts the query will return a value of 1 to indicate the instrument is being Reset.

**RI?**

Read the remote Interlock input signal. When the remote Interlock has been activated by opening the contacts the query will return a value of 0 to indicate the instrument is in the Interlock state and will not be able to generate output voltage or current.

**RS?**

Read Scanner Status command will respond with a value that identifies the number of scanners installed or connected to the instrument. Values 0 – 4 will indicate if there are no scanners connected, one Internal or External scanner, or if both an Internal and an External scanner are connected.

**LF?**

Lists the file name of the memory loaded into active memory (RAM).

**LFN?**

Lists the memory number of the active memory file loaded into active memory (RAM).

**LF <memory number>?**

List the file name of any of the 50 memories.

**LP?**

Lists the prompt that is created for the selected step within active memory (RAM).

**LP <step number>?**

Lists the prompt that has been created for a particular step of the file within active memory (RAM).

**LS?**

Lists all the parameters for the individual step that is currently selected. See the ADD command for the list of parameters. A comma (,) will separate each parameter and will be preceded with the step number.

**LS <step number>?**

Lists all the parameters for the individual step indicated by *step number* = 1-30. See the ADD command for the list of parameters. A comma (,) will separate each parameter and will be preceded with the step number.

**SS?**

Lists the active step number.

## SF?

Lists the condition of the Fail Stop feature.

### 7.4.7. IEEE 488.2 Common Commands

These commands are required by the IEEE-488.2 standard with the exception of \*PSC, \*PSC?. Most of these commands are not available over the USB/RS-232 bus except for the \*IDN? command which can be used to retrieve the instrument identification information, and the four status reporting commands \*ESR?, \*ESE, \*ESE? and \*STB?

COMMAND	NAME	DESCRIPTION
*IDN?	Identification Query	Associated Research Inc., Model Number, Serial Number, Firmware Revision
*RST	Reset Command	Resets 620L
*TST?	Self-Test Query	00H=OK 01H=TEST EEPROM ERROR
*CLS	Clear Status Command	Clear Standard Event Status Register Clear Service Request Register
*OPC	Operation Complete Command	When all selected pending operations complete, ESR BIT0=1
*OPC?	Operation Complete Query	When all selected pending operations complete, Output Queue=1
*WAI	Wait-to-Continue Command	
*PSC {1 0}	Power-on Status Clear Command	1 = Power-on clear enable registers 0 = Power-on load previous enable registers
*PSC?	Power-on Status Clear Query	
*ESR?	Standard Event Status Register Query	0 - 255
*ESE <value>	Standard Event Status Enable Command	value = 0 - 255
*ESE?	Standard Event Status Enable Query	0 - 255
*STB?	Read Status Byte Query	Read Status Byte
*SRE <value>	Service Request Enable Command	value = 0 - 255
*SRE?	Service Request Enable Query	0 - 255

## \*IDN?

Read the instrument identification string. Company = Associated Research Inc.

**\*RST**

Reset the instrument to original power on configuration. Does not clear Enable register for Standard Summary Status or Standard Event Registers. Does not clear the output queue. Does not clear the power-on-status-clear flag.

**\*TST?**

Performs a self-test of the instrument data memory. Returns 0 if it is successful or 1 if the test fails.

**\*CLS**

Clears the Status Byte Summary register and Event registers. Does not clear the Enable registers.

**\*OPC**

Sets the operation complete bit (bit 0) in the Standard Event register after a command is completed successfully.

**\*OPC?**

Returns an ASCII "1" after the command is executed.

**\*WAI**

After the command is executed, it prevents the instrument from executing any further query or commands until the no-operation-pending flag is TRUE.

**\*PSC {1|0}**

Sets the power-on status clear bit. When set to 1 the Standard Event Enable register and Status Byte Enable registers will be cleared when power is turned ON. 0 setting indicates the Enable registers will be loaded with Enable register masks from non-volatile memory at power ON.

**\*PSC?**

Queries the power-on status clear setting. Returns 0 or 1.

**\*ESR?**

Queries the Standard Event register. Returns the decimal value of the binary-weighted sum of bits.

**\*ESE <value>**

Standard Event Enable register controls which bits will be logically OR'd together to generate the Event Summary bit 5 (ESB) within the Status Byte.

**\*ESE?**

Queries the Standard Event enable register. Returns the decimal value of the binary-weighted sum of bits.

**\*STB?**

Read the Status Byte. Returns the decimal value of the binary-weighted sum of bits.

**\*SRE <value>**

Service Request Enable register controls which bits from the Status Byte should be used to generate a service request when the bit value = 1.

**\*SRE?**

Queries the Service Request enable register. Returns the decimal value of binary-weighted sum of bits.

**7.4.8. Status Reporting**

The status reporting system is a way of determining the condition of the tester and is configured using two types of registers. An Event register and a Summary register. The Summary register is known as the Status Byte register and records high-level summary information acquired by the Event registers.

An Event register report defines conditions or messages at each bit. The bits are latched and remain in an active state until the register is either Read or Cleared. Reading the Event register automatically clears the register and sets all bits to an inactive state or 0. When querying an Event register the information is returned as a decimal number representing the binary-weighted sum of all bits within the register.

The Enable register bits represent the selection of bits that will be logically OR'd together to form the summary bit in the Status Byte. The \*CLS command will not clear the Enable registers and if you wish to clear the register you must set it to a value of 0. Like the Event register, the Enable register is represented as a decimal number that equals the binary-weighted sum of all bits.

The Enable register will clear to a value of 0 at power-on unless the \*PSC 0 command has been executed before power-off. The \*PSC command tells the device whether or not it should clear the Enable registers at power-on. Using this command will allow SQRs to function immediately after power-on.

Bit	Binary weight	EVENT REGISTER		STATUS BYTE REGISTER	
		Event Register	Enable Register	Summary Register	Enable Register
0	1	Operation Complete		ALL PASS	
1	2	not used		FAIL	
2	4	Query Error		ABORT	
3	8	Device Error		TEST IN PROCESS	
4	16	Execution Error		Message Available (MAV)	
5	32	Command Error		Event Summary Bit (ESB)	
6	64	not used		Request Service (RQS) or Master Summary Status (MSS)	not used
7	128	Power On		PROMPT	

---

\*ESR?

\*ESE

\*STB? | SPOLL

\*SRE

\*ESE?

\*SRE?

#### **7.4.9. GPIB Service Request**

The service request capability is not available with the USB/RS-232 interface. The SRQ line will be activated only after one or more of the service request functions have been enabled using the Status Byte Enable register command \*SRE.

The Status Byte bit assignments are as described in the previous section for status reporting. When the instrument has requested service, the enabled bit or bits and the RQS bit 6 will be active or 1. Bits 4, 5, and 7 are not used and will be set to false, or 0 for all Status Byte reads.

After the serial poll (SPOLL) is executed the RQS bit will be cleared to 0 and the remaining bits will remain unchanged. The Status Byte will not change value until the Event register is read and cleared for the corresponding Status Byte bit.

For example, after the All Pass SRQ has been enabled, when the test(s) have finished with pass indications the instrument will set the hardware SRQ line and output the Status Byte of 41 hex. This means that bit 6 and bit 0 are set to a value of 1. After reading the Status Byte the Status Byte value will change to 01 hex.

## 7.5. Non Volatile Memory

The instrument saves or deletes each parameter in non-volatile memory when the file save "FS", file save as "FSA", file new "FN" and file delete "FD" commands are used to save, create and delete the files. The non-volatile memory has a limited write cycle life. Therefore, for programmers who wish to send all parameters before executing each test, the following commands should not be used:

FS – File Save

FSA – File Save As

FN – File New

FD – File Delete

The parameters will be stored in the CPU's Random Access Memory (RAM) until another memory location is selected. However, settings written to RAM from GPIB/USB/RS-232 mode will be lost when power is shut down. Parameter changes to RAM are unlimited and will not affect the life of the internal non-volatile memory chip.

A flowchart for an example program is shown on the next page. This flowchart exhibits how a program could be written to minimize wear to the write life cycle of the non-volatile memory. First, the "FN" command is used to create a blank file. In this case, the file is named TEMP. This file is then stored into the memory of the 620L. When the sequence needs to be recalled, the "FL" (File Load) command is used to recall the TEMP file. This creates a blank test sequence and steps can be added as necessary. Then the steps are added to the file via the "ADD" command and the sequence is executed. Programming in this fashion, the "FN" command is only used once to create a sequence. Then that sequence can be constantly loaded with the "FL" command and added to with the "ADD" command. This will avoid constantly writing to the non-volatile memory.



## Programming flow Charts

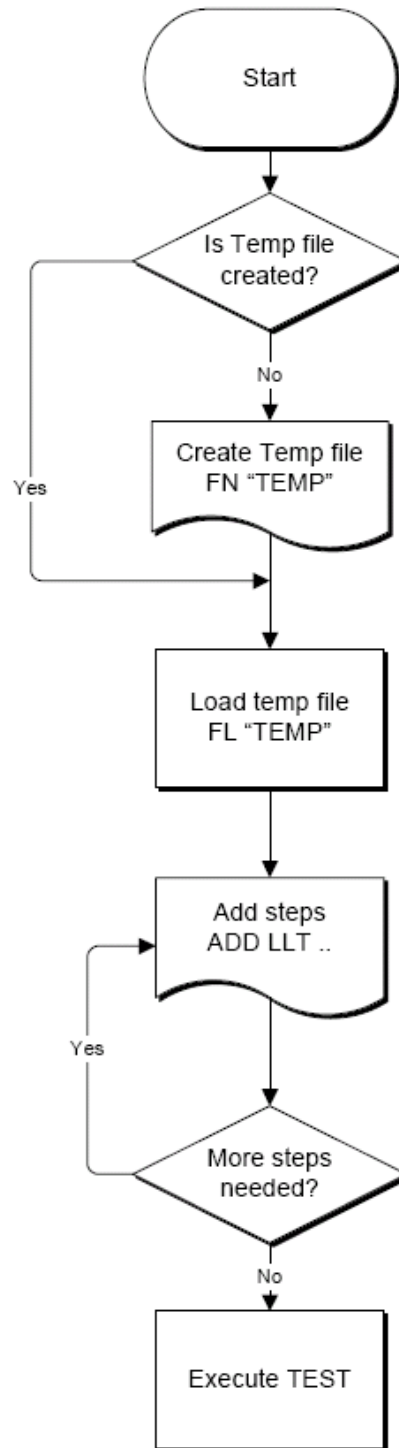

**FOR MORE INFORMATION ON IEEE (GPIB) PLEASE CONTACT**

The Institute of Electrical and Electronic Engineers, Inc.  
345 East 47th Street,  
New York, NY 10017  
☎ 1-212-705-7018 (Communications Society of IEEE)  
Internet: [www.ieee.org](http://www.ieee.org)

## 8. OPTIONS

### Introduction

This section contains a list and descriptions of available factory installed options at the time of this printing. The list of options contains an option code number that can be referenced on the data plate on the rear panel of the unit.

### Option Label

On the rear panel of the instrument, you will find a label that contains the option code.

For example, your options code would appear as follows:

Fitted with option 01 ..... OPT: 01  
 Fitted with option 01 and 02..... OPT: 0102

### 620L Options

#### Option List

CODE	DESCRIPTION
01	GPIB
02	Run Test Function (Standard)
03	Hipot/Ground Bond Interconnect
04	Scanner (Standard)
05	LineChek to APT 7 Memory (Standard)
06	Ethernet Card
07	Data Storage Card (DISCONTINUED)
08	Leakage Current Offset Circuit

Note – Option 02, 04, and 05 are now standard.

#### 01 GPIB Interface

This option may be substituted for the USB/RS-232 interface. This option provides all of the functional control of the USB/RS-232 interface with the addition of SRQ functions. All commands can be found in section **7. Bus Remote Interface GPIB/USB/RS-232**.

#### 03 Hipot/Ground Bond Interconnect

This option gives the 620L the capability to interface with an Associated Research Hipot or Ground Bond tester. Three (3) additional input ports (HV, Return, and CASE) and one (1) additional output port (Current) are added to the back panel of the instrument, which should be used to connect the safety tester to the 620L. For more information on the HV, Return, CASE, and Current connections, please refer to section **3.2.2. Rear Panel Controls**.

---

The operator must also connect the included communication cables to the Remote Signal I/O's of both the 620L and the electrical safety tester. These cables will provide the communication path for the instruments to function together.

With this option installed, the 620L and the electrical safety tester will operate in a master/slave configuration. The test will be initiated from the front panel TEST button of the 620L. Once the test is complete, the 620L will send a signal to the electrical safety tester to begin any subsequent tests.

- **Note:** The PLC Remote parameter in the electrical safety tester's System Menu screen must be turned ON for this option to work.

Additionally special cables are available that make it possible for the test to be started with the safety tester first. With these special cables, the electrical safety tester and the 620L will operate in a master/slave configuration. The test will be initiated from the front panel TEST button of the accompanying electrical safety tester. Once the test is complete, the electrical safety tester will send a signal to the 620L to begin any subsequent leakage tests.

- **Note:** The PLC Remote parameter in the 620L's System Menu screen must be turned ON for this option to work.
- **Note:** In this configuration the electrical safety tester will send test signal to the 620L but is not able to send a reset signal once the test on the 620L has started. RESET button on the 620L would need to be pressed at the end of the test sequence in order to reset the 620L or abort a test.

In the above configuration, the 620L will act as a "feed-through" for the electrical safety tester, providing the necessary high voltage and high current signals to the DUT through the DUT Power Outputs (line and neutral) and the CASE connector. The adapter box as well as the standard test leads may be used with this option.

**CAUTION**

When using the interconnect option, the High Voltage output of the electrical safety tester must be limited to 3.5 kV and the Current output must be limited to 40A in order to keep from damaging the 620L.

**CAUTION**

The standard 10 AWG black cables (included) are not equipped to handle the high voltages associated with a Hipot test. When using the 620L with option 03 Hipot/Ground Bond Interconnect, make sure to use the included 10 AWG white high voltage cables for the DUT Power Output connections.

The following figure shows how to connect the 620L to an Associated Research HypotULTRA III tester.

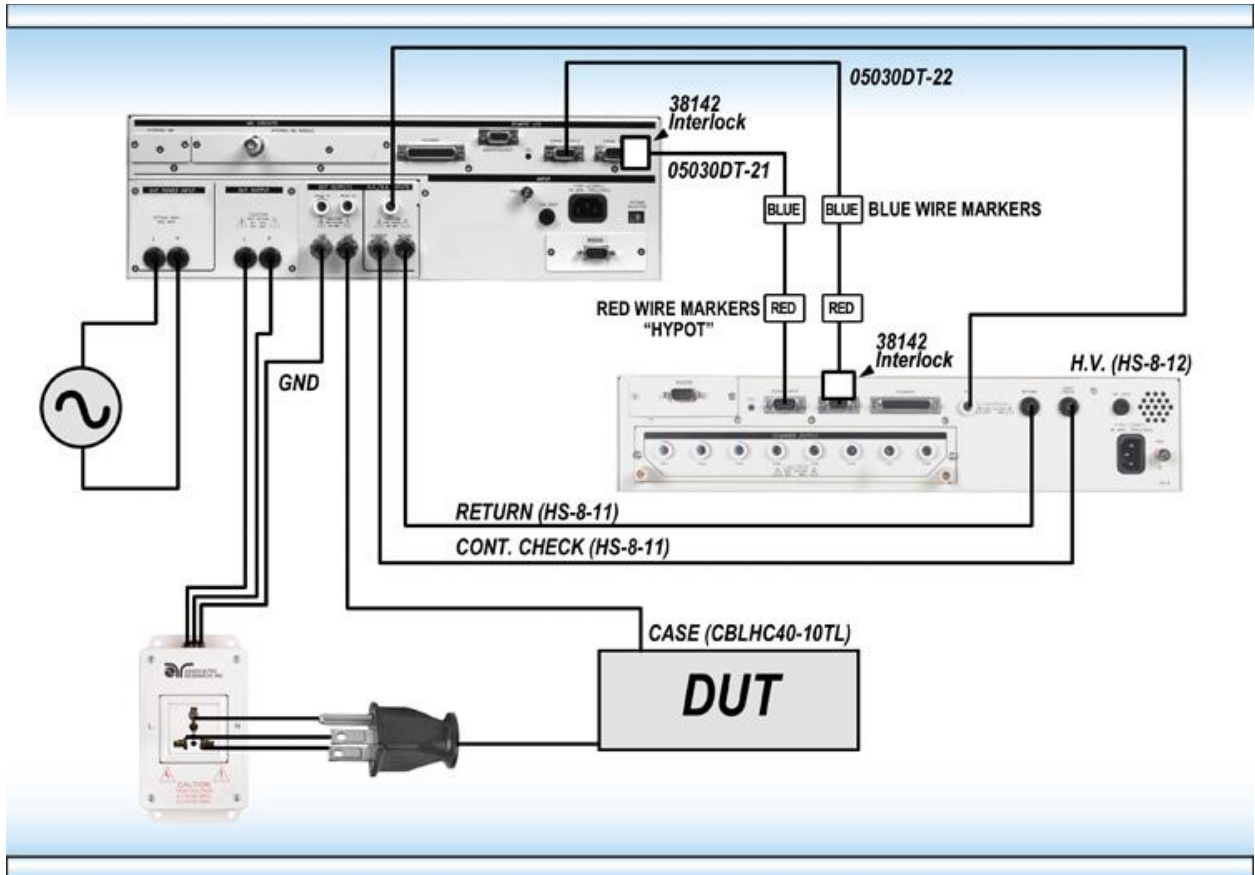

The following figure shows how to connect the 620L to an Associated Research Omnia 8104 tester.

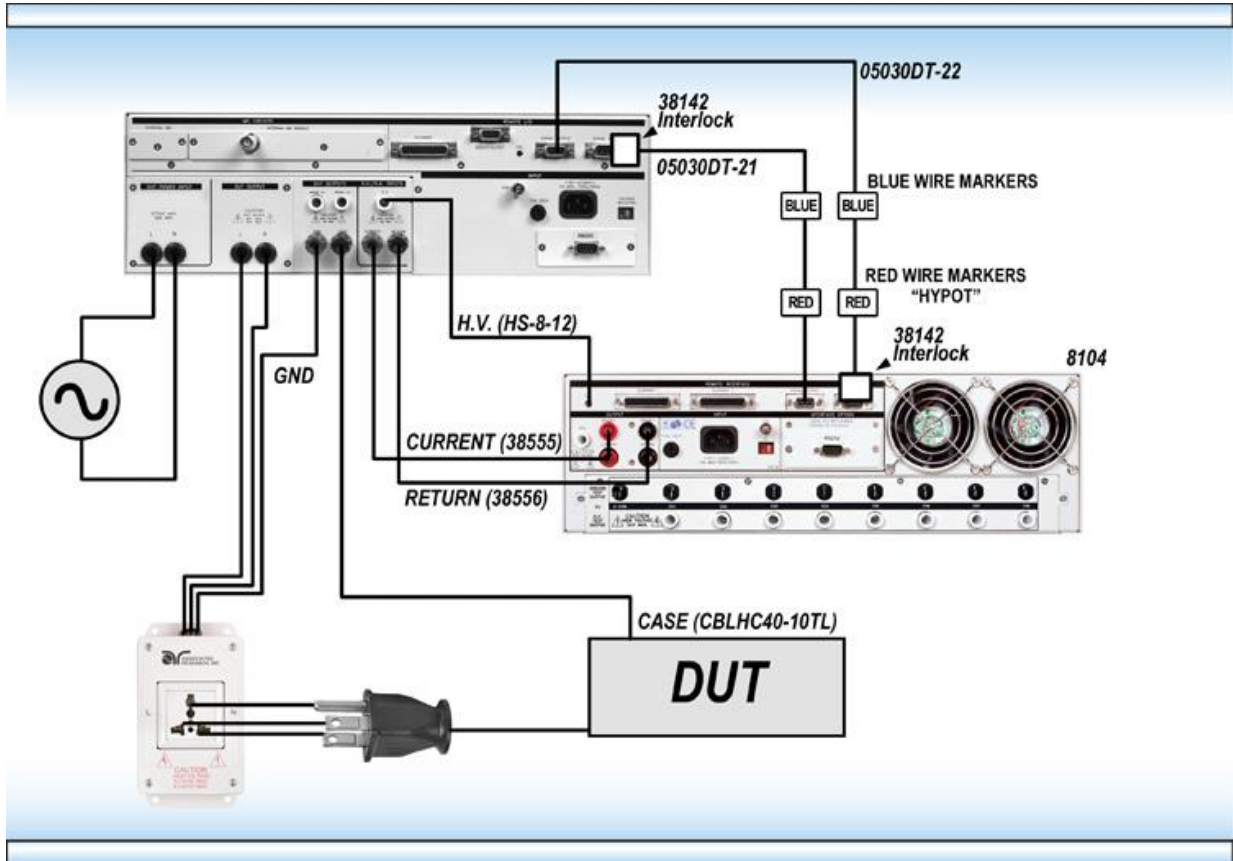

The following figure shows how to connect the 620L to an Associated Research HypotULTRA III tester using special cables to perform hipot test first followed by line leakage test.

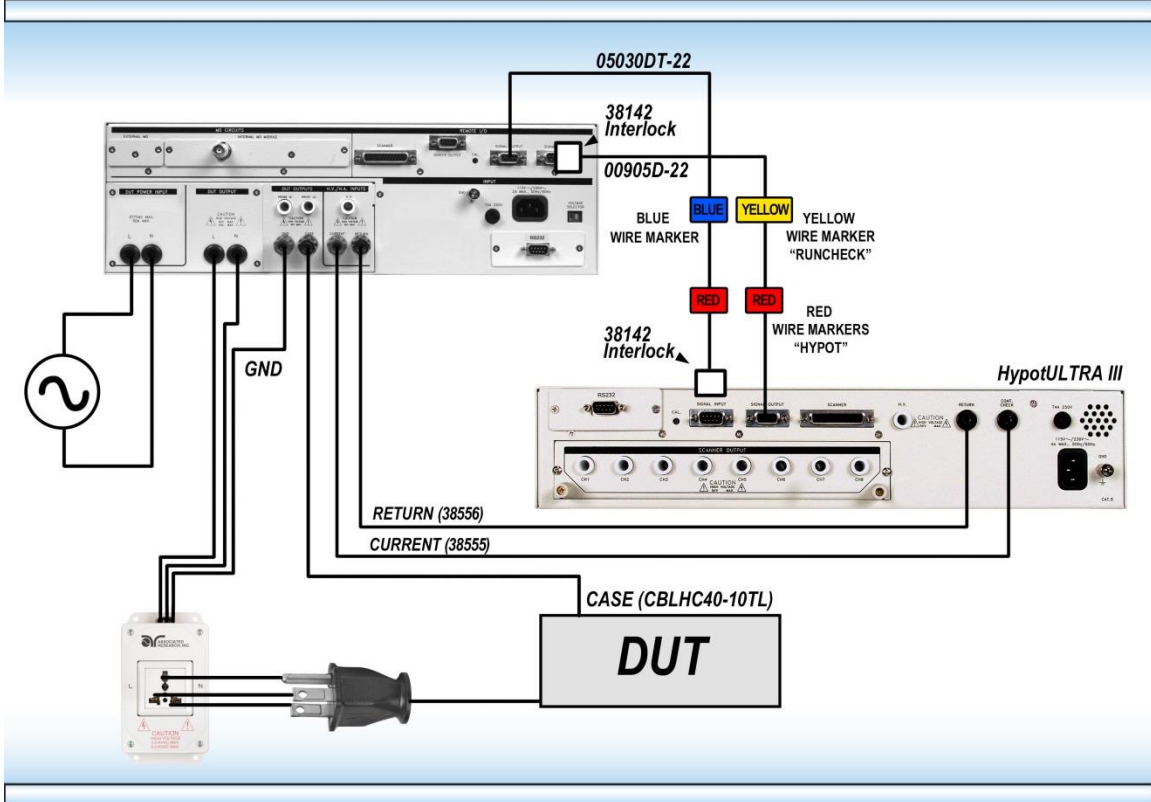

The following figure shows how to connect the 620L to an Associated Research Omnia 8104 tester using special cables to perform hipot test first followed by line leakage test

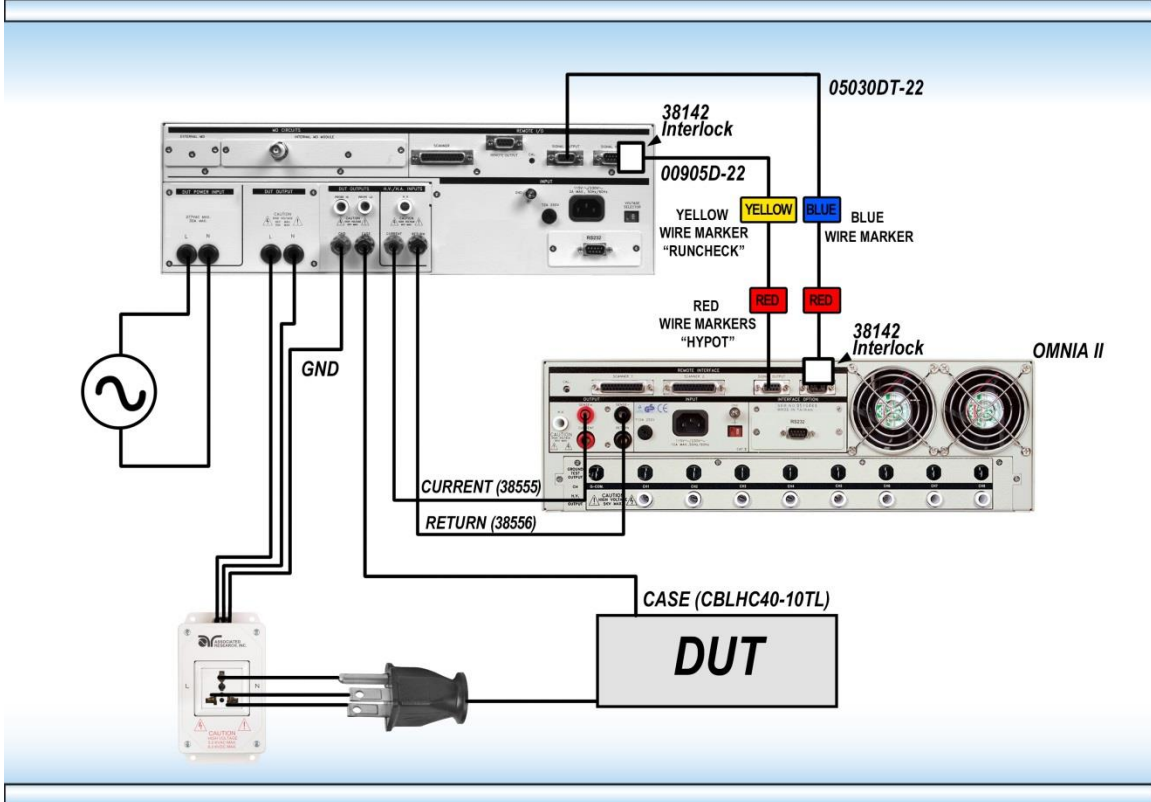

### 05 LineChek to APT 7 Memory

This option provides a dedicated signal output connector that is added to the rear panel of the 620L. The new signal output connector can be used to control a compatible device such as an AC 1000 power supply. The output is a 3-bit digital control signal that is menu selectable at the Run Test or LLT parameter screen.

This option is provided with a cable which is designed to interconnect the 620L 9-pin Remote Output to the AC 1000 Remote I/O input. This cable, p/n 38774, is a standard 9-pin female to 9-pin male. See the following figure for connecting the 620L to the AC1000:



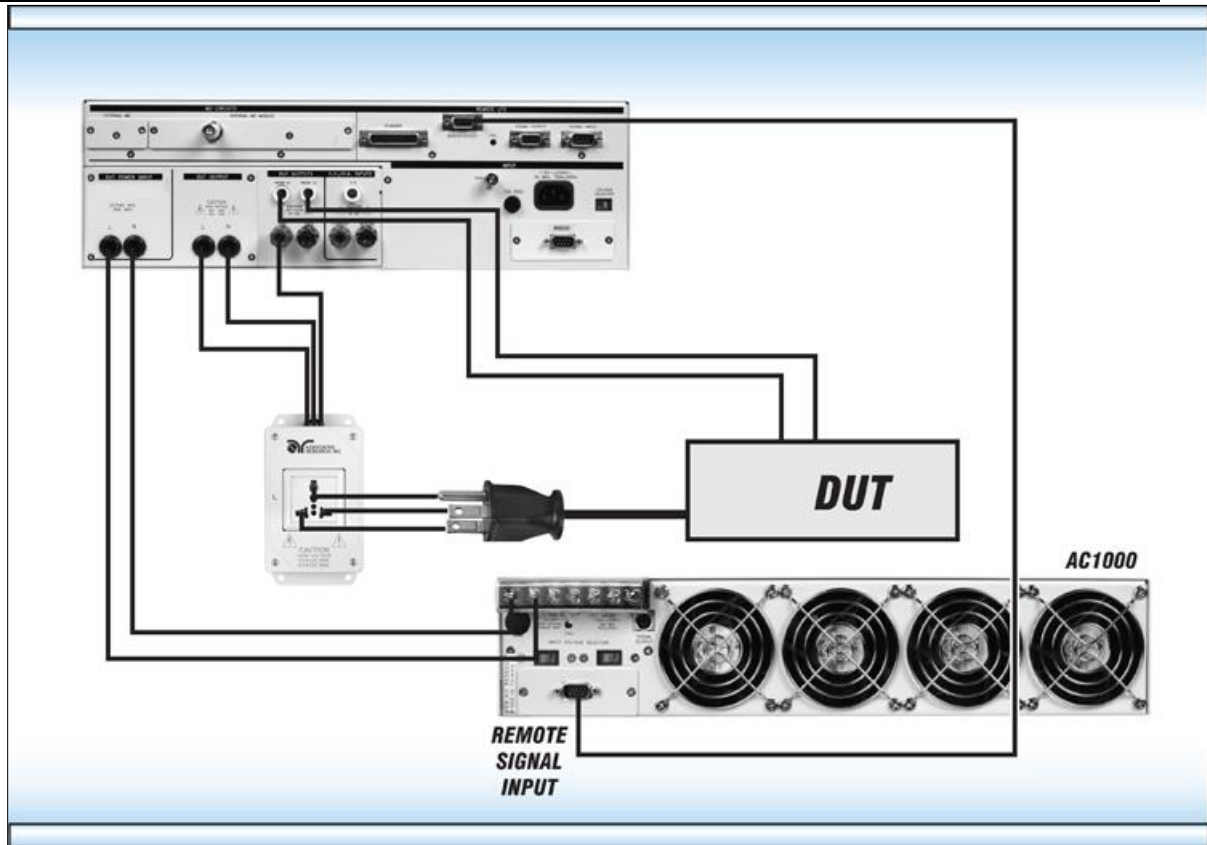

When using this option with an AC 1000, be sure to power up the 620L first and then power up the AC 1000. When powering down the instruments, power down the AC 1000 first and then power down the 620L. The 620L is in an undetermined state without power and may cause inadvertent memory activation of the AC 1000. If you would like to operate the AC 1000 independently of the 620L, either disconnect the interface cable or disable the PLC remote on the AC 1000.

The Remote Memories send signals are provided by three high voltage, high current Darlington drivers. These are open collector devices capable of sinking 350mA at voltages as high as 95 VDC.

With this option installed, a new soft key selection will appear on the Run Test or LLT Parameter screen. The new soft key, called PLC Control will toggle between M1 through M7 when pressed.

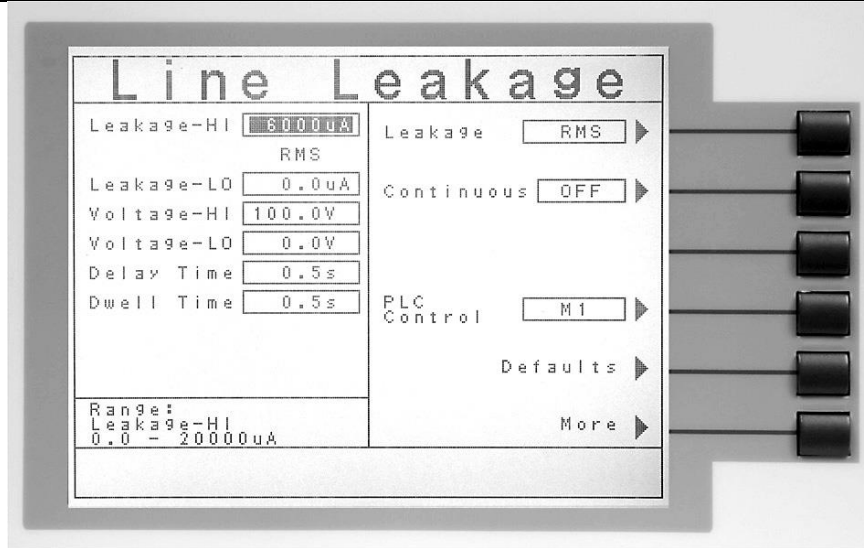

Setting the PLC Control selection to M1 through M7 will create different digital states at Bit 0, Bit 1, and Bit 2 of the PLC Remote Signal Output (refer to the PLC Signal Output drawing below). The different states are described in the truth table below. The “Not used” state is undefined and cannot be programmed for use.

BIT 2	BIT 1	BIT 0	TEST VOLTAGE SETTING
0	0	0	Not used
0	0	1	M1
0	1	0	M2
0	1	1	M3
1	0	0	M4
1	0	1	M5
1	1	0	M6
1	1	1	M7
0 = OPEN			1 = CLOSED

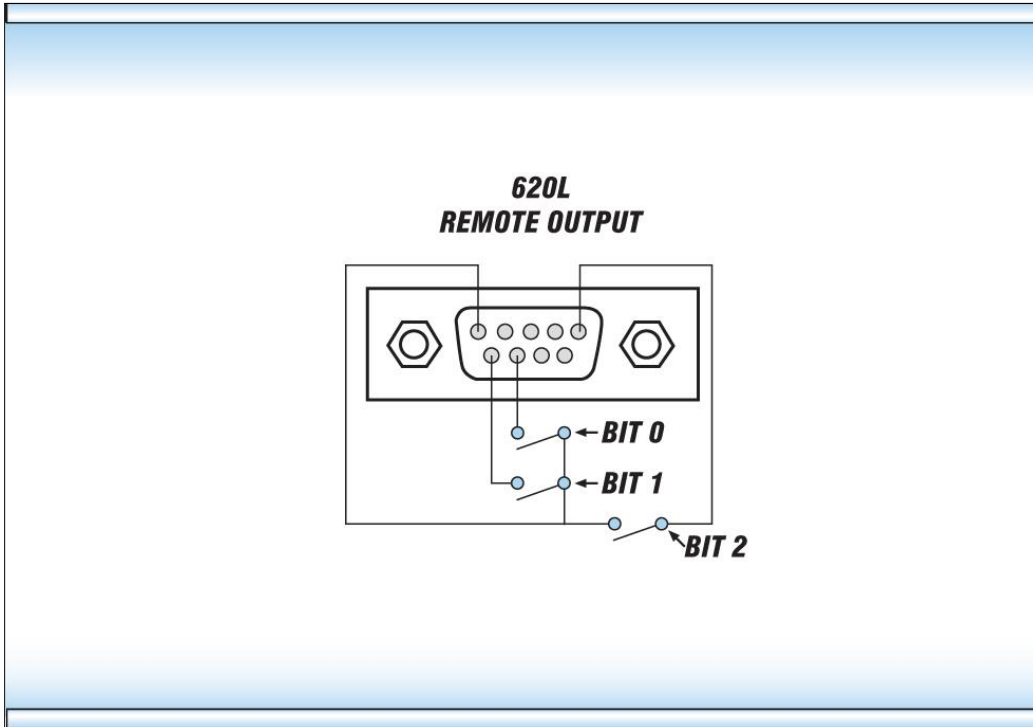

The following Test Parameter Editing GPIB commands may be used to control the memory send selection.

COMMAND	NAME	TEST TYPES	VALUE
EPM n, n=1-7 EPM?	Edit PLC Memory Send	LLT RUN	1=M1, 2= M2, 3=M3, 4=M4, 5=M5, 6=M6, 7=M7

The ADD command can also be used. The memory selection should be inserted as the last parameter and should use full text as indicated on the LCD screen such as M1 or M2.

### **EPM**

Sets the AC1000 memory location to be used during a Line Leakage or Functional Run test.

### **06 Ethernet Card**

The Ethernet Card option provides RS-232 and Ethernet communication interfaces, as well as barcode scanning capability.

The Ethernet Card has three input/output ports, shown in the following figure:

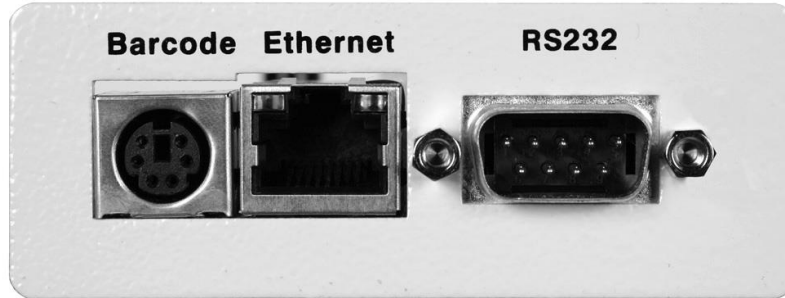

The port labeled “Barcode” is a PS/2-type connector that is used for the connection of a barcode scanner. The Ethernet port is for use with a standard CAT-5 Ethernet cable and may be connected to any compatible PC. The 9-pin D-type subminiature connector labeled “RS232” is for connection of the 620L to an RS-232 communication bus.

### **USB/RS-232 Interface**

The protocol for interfacing and communicating using the USB/RS-232 interface can be found in section **7. Bus Remote Interface GPIB/USB/RS-232** of this manual.

### **Ethernet Interface**

The Ethernet interface provides all of the function control of the standard RS-232 interface. Some commands are only exclusive to GPIB control.

### **Default Settings**

The default settings for the Ethernet interface are as follows:

IP Setup:     AUTO  
IP Address:  010.000.000.000  
Gateway IP:  000.000.000.000  
Subnet Mask: 255.000.000.000

The source port number for the Ethernet Card in TCP connections is 10001.

### **Ethernet Card Setup**

In order to setup the Ethernet card, the operator will need information from the local network administrator. Please have your network administrator fill out the required information on the next page and keep it for your records:

**Associated Research, Inc.**  
**Ethernet Card Communications Information**  
(To be completed by Network Administrator)

**Ethernet Card Address:** \_\_\_\_\_:\_\_\_\_\_:\_\_\_\_\_:\_\_\_\_\_:

**Device Name:** \_\_\_\_\_

**Device IP Address:** \_\_\_\_\_.

**Gateway IP Address:** \_\_\_\_\_.

**Subnet Mask:** \_\_\_\_\_.

### Saving New Settings

Any time the user edits one of the Ethernet Card parameters and exits the Ethernet Card Settings menu, the following message will be displayed:



The Ethernet Card will attempt to re-establish a connection with the server anytime the user modifies a parameter and exits the Ethernet Card Parameters Menu or uses the command set at the end of this option description. Thus, if the IP Setup is set to AUTO, the Ethernet Card will request a new IP Address every time a parameter is edited and, as a result, the "Requesting IP Address. . ." message will appear.

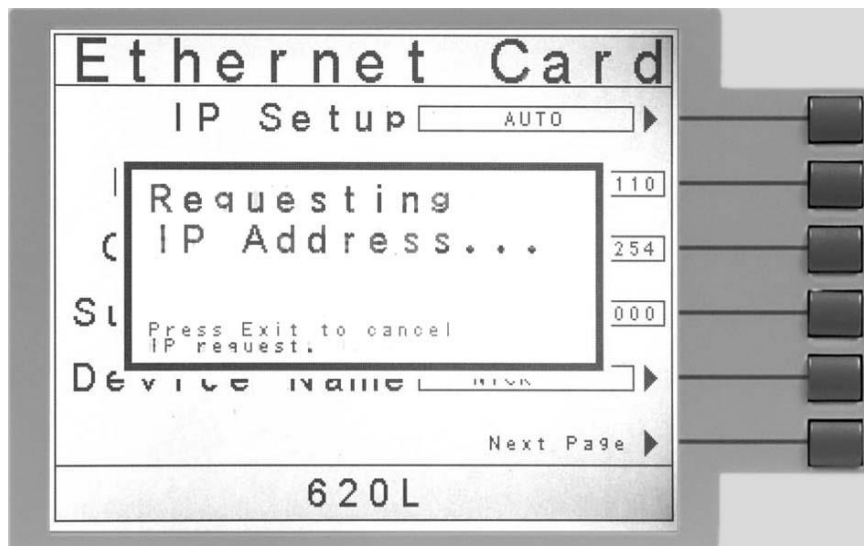

### Power Up

The Ethernet Card will be installed with the default options listed above. After the 620L initially powers up, the following pop-up message will appear:

**Note:** The “Requesting IP Address...” pop-up message only appears at power up when the Ethernet Card has its IP Setup configured to AUTO.

There are two options to choose from this screen. Press the EXIT key to escape from this screen and stop the 620L from requesting an IP address or allow the 620L to request an IP address automatically from the network to which it is connected.

The Ethernet Card will wait for an IP Address for approximately 20 seconds. If the 620L successfully receives an IP Address from the server the following pop-up message will be displayed:

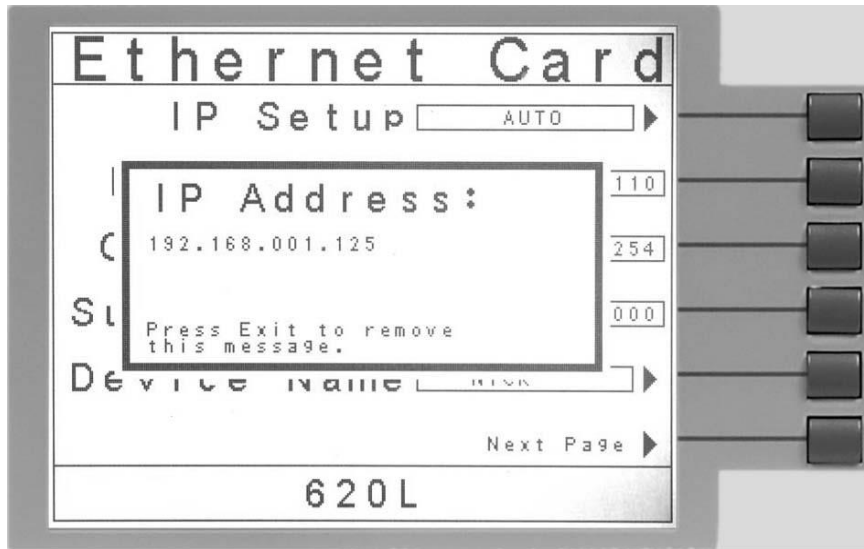

If the 620L fails to receive an IP Address after approximately 20 seconds, the following pop-up message will be displayed:

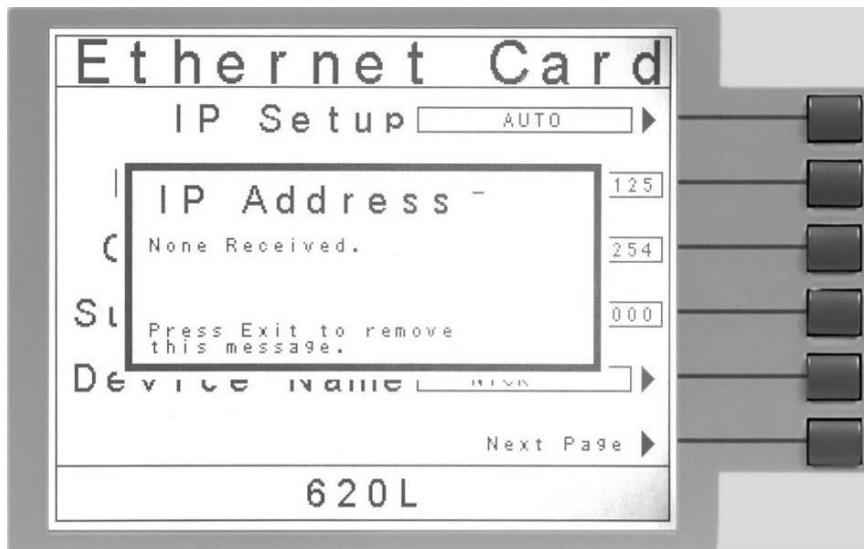

Press the EXIT key to remove the pop-up message and return to the 620L's Main Menu Screen.



### Ethernet Card Menu

When the Ethernet Card option is installed, the Ethernet Card Menu will appear in the Setup System Screen as shown below:

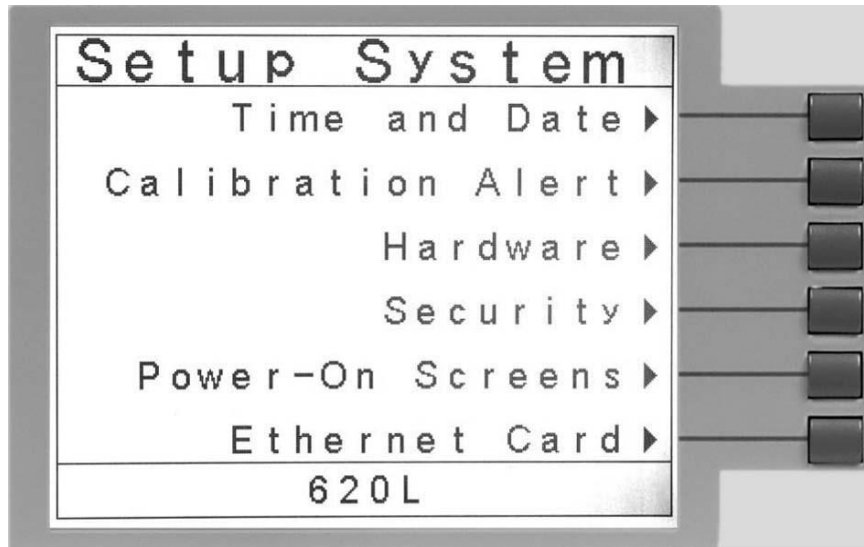

To access the Ethernet Card Menu, press the “Ethernet Card” soft key from the Setup System screen. The Ethernet Card Parameters screen will now be displayed as shown below:

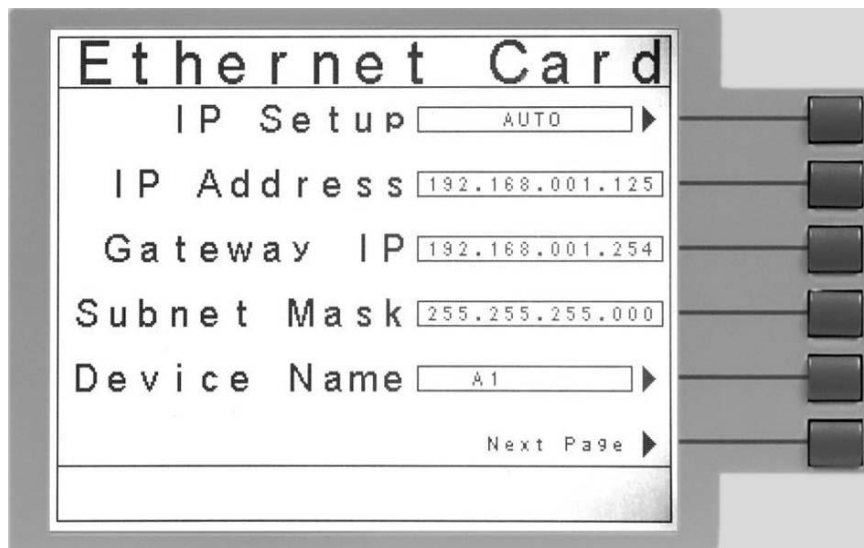

From the Ethernet Card Parameters screen, six different parameters may be accessed: IP Setup, IP Address, Gateway IP, Subnet Mask, Device ID, and Next Page.

### IP Setup

The “IP Setup” soft key is used to determine how the 620L will request an IP address from the server to which it is connected. The IP Setup may be configured as AUTO or MANUAL by pressing the “IP Setup” soft key.

When AUTO is selected, the 620L will attempt to automatically request an IP Address from the server upon power up. To resolve the IP Address automatically, the 620L will use DHCP or BOOTP protocols. When MANUAL is selected, the 620L will request a specific IP Address from the server. The IP Address that will be requested must be entered in the subsequent IP Address parameter field.

### IP Address

A specific IP Address must be entered into this field if the IP Setup parameter is configured to MANUAL. Use the arrow keys to highlight this parameter. Once the parameter is highlighted, enter the IP Address that you wish using the numeric keypad. The IP Address must be entered in the following format: XXX.XXX.XXX.XXX. A valid IP Address must be entered. Users may not use the following IP Addresses:

255.255.255.255  
000.000.000.000

Enter the preceding IP Addresses will cause the following error message to be displayed:

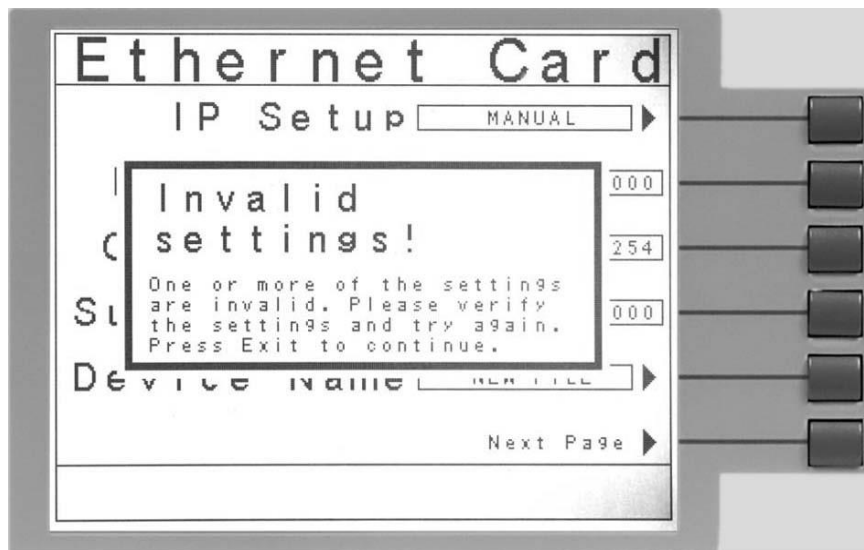

Press the EXIT key to save the new settings. If the IP Setup parameter is set to AUTO, you do not need to enter an IP Address manually.

### Gateway IP

A specific Gateway IP must be entered into this field if the IP Setup parameter is configured to MANUAL. Use the arrow keys to highlight this parameter. Once the parameter is highlighted, you may enter the Gateway IP using the numeric keypad. The Gateway IP must be entered in the following format: XXX.XXX.XXX.XXX. Press the EXIT key to save the new settings. If the IP Setup parameter is set to AUTO, you do not need to enter a Gateway IP manually.

### Subnet Mask

A specific Subnet Mask must be entered into this field if the IP Setup parameter is configured to MANUAL. Use the arrow keys to highlight this parameter. Once the parameter is highlighted, you may enter the Subnet Mask using the numeric keypad. The Subnet Mask must be entered in the following format: XXX.XXX.XXX.XXX. If an invalid Subnet Mask is entered the following error message will be displayed:

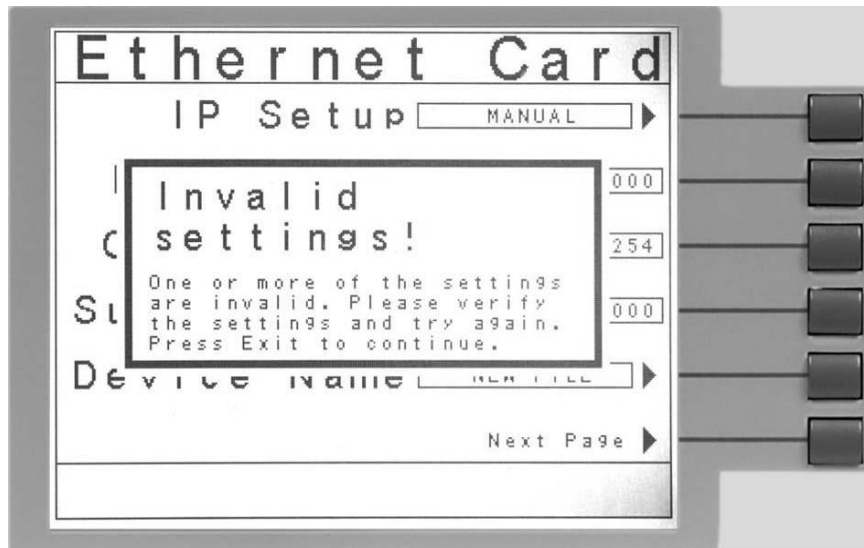

Press the EXIT key to save the new settings. If the IP Setup parameter is set to AUTO, you do not need to enter a Subnet Mask manually.

### Device Name

Press the "Device Name" soft key to bring up the Device Name screen, which will appear as follows:

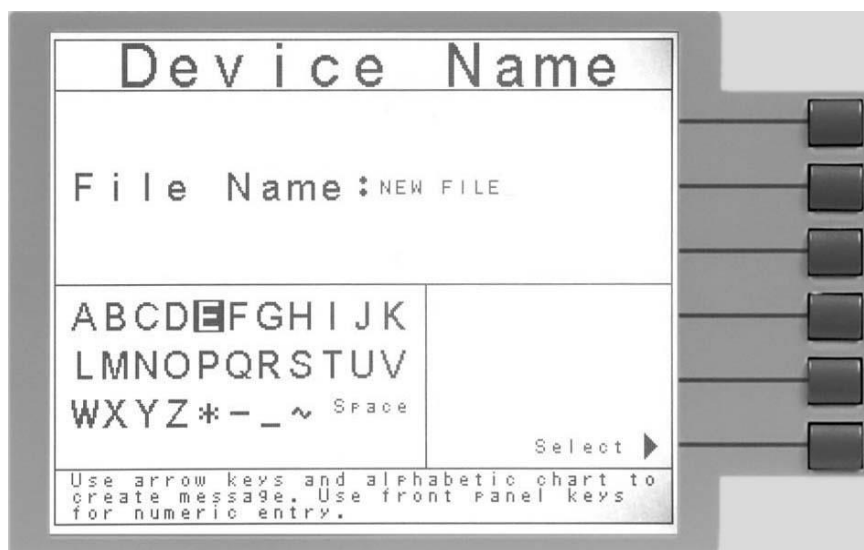

From this screen you may enter a Device Name for the 620L. The Device Name is used to identify the 620L on your server and may be used in place of a dedicated IP Address. Use the arrow keys to highlight a letter and press the “Select” soft key to select the highlighted letter. The Device Name may be a maximum of eight characters and MUST start with a letter. If the Device Name does not start with a letter the following error message will be displayed:

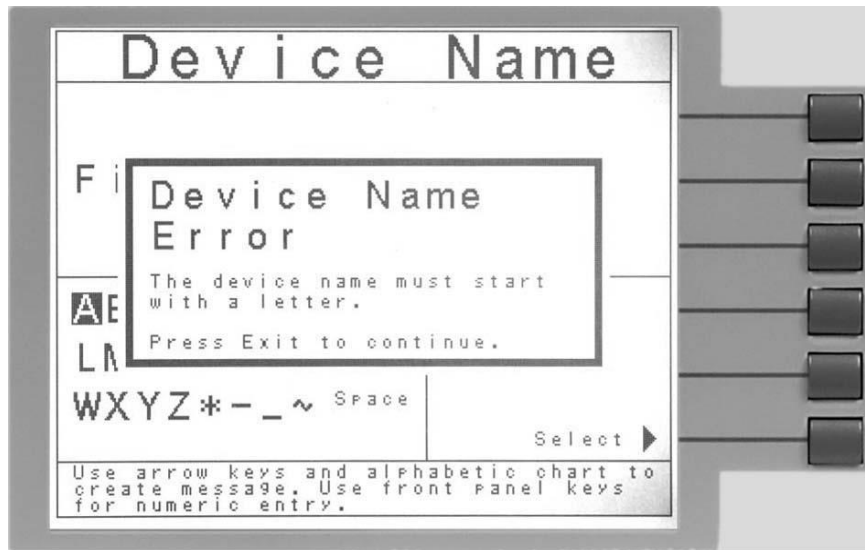

When the Device Name has been entered, press the EXIT key to save the new settings. The Device Name parameter is only active when the IP Setup is set to AUTO.

**Next Page**

Press the “Next Page” soft key to bring up additional parameters as shown in the following screen:

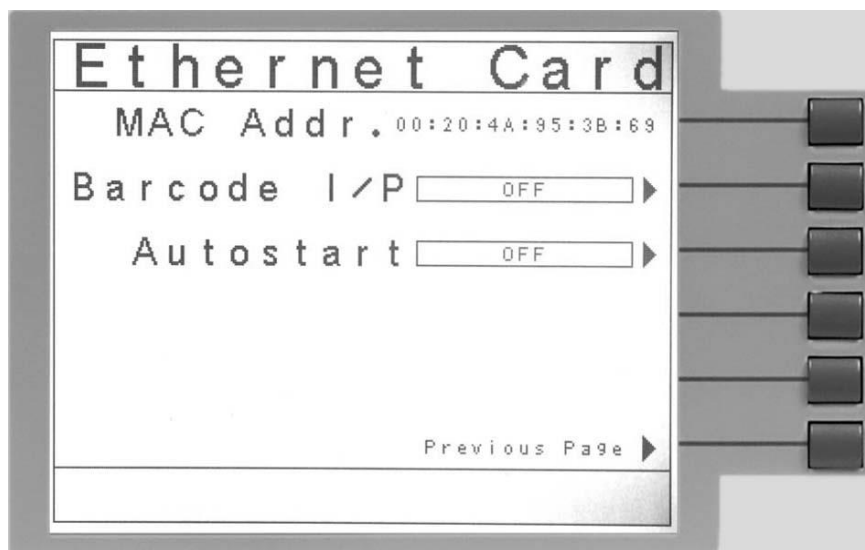

From this screen, four parameters may be accessed: MAC Address, Barcode I/P, Autostart, and previous page.

### MAC Address

View the MAC address of the Ethernet Card here. This parameter is not adjustable.

### Barcode I/P

Press the “Barcode I/P” soft key to select the type of Barcode input. The Barcode I/P parameter can be set to SERIAL#, PRODUCT#, SER/PROD, OFF or RUN FILE. When the setting is SERIAL#, PRODUCT# or SER/PROD, the user can scan barcodes in the Perform Tests screen before the test is started. When a barcode is scanned, one of the following messages will appear on the display.

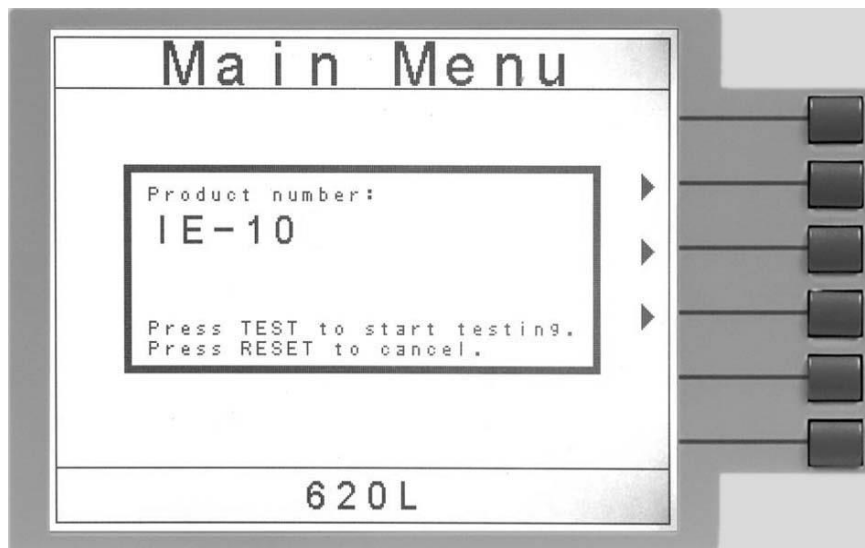
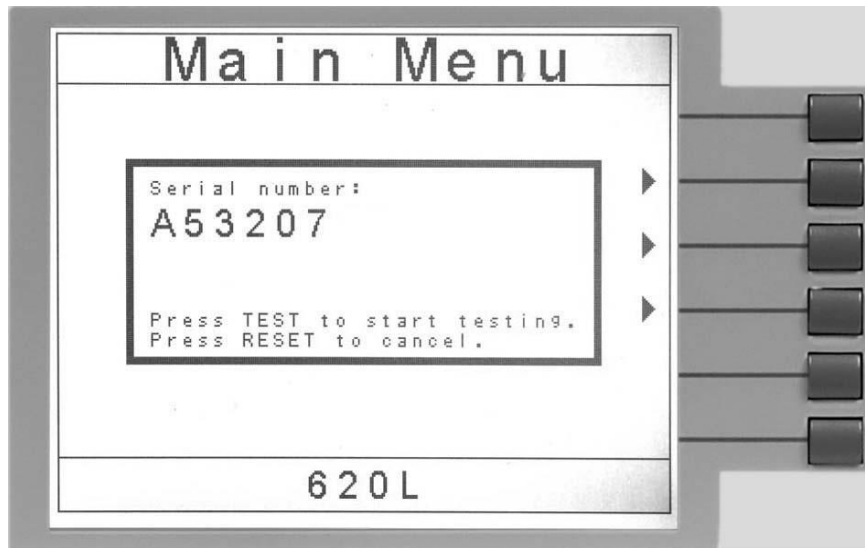

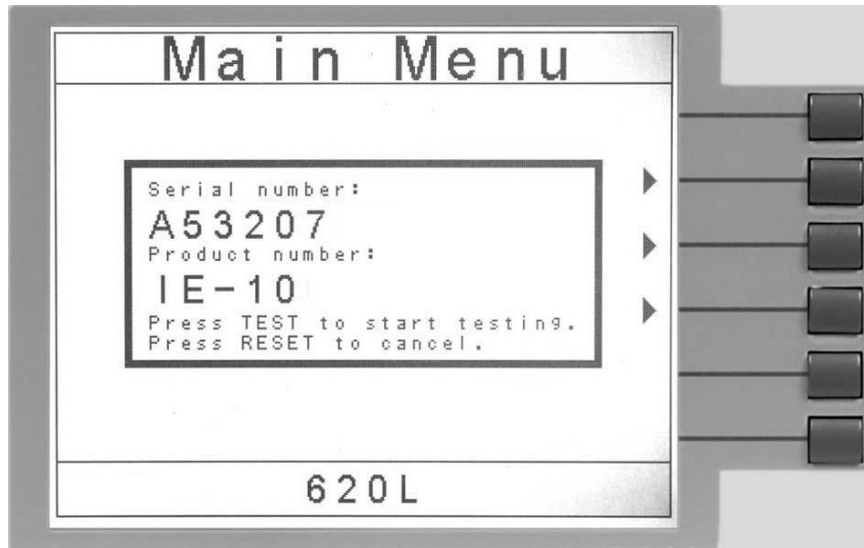

After the barcodes are scanned, press TEST to initiate the test sequence. Pressing RESET will abort the TEST sequence.

The Ethernet Card permits re-scanning of barcodes if the previously scanned barcode was incorrect. Re-scanning is only available in the SERIAL#, PRODUCT# and SER/PROD modes. If the user decides to re-scan barcodes when the Barcode I/P setting is set to SER/PROD, the Ethernet Card will first replace the data in the Serial Number field, and if the user re-scans another barcode, the Ethernet Card will replace the data in the Product Number field.

The RUN FILE selection gives the user the ability to automatically load and execute a test file based on what barcode is scanned from the Perform Tests screen. In order for this feature to work, the user must name the desired test file with the exact alphanumeric code that is on the product's barcode label. For example, if Product A has barcode "123456789", then the test file that the user would like to run when testing Product A should be named "123456789". When the product's barcode is scanned, the 620L will immediately execute the test associated with that barcode. The test file name is limited to 10 characters. However, if the user names a test file with the maximum 10 characters, this function will still initiate a test when a product's barcode begins with those first 10 characters even if the barcode has more than 10 characters.

**WARNING**

Using the RUN FILE feature will enable the instrument's output once the barcode is scanned. Do not touch the DUT at any time when using this feature in order to avoid potential shock or serious injury.

When using a barcode scanner, the 620L's responses to the TD? and RD x? commands will differ slightly from an 620L with the standard USB/RS-232 interface. For all types of tests (LLT, RUN) two fields are added to the end of the standard response when the Barcode I/P setting is set to SERIAL#, PRODUCT# or SER/PROD. The first field contains the Serial Number information and the second field contains the Product Number information. Both fields are included regardless of which of these three modes are selected. The Ethernet Card will substitute a "0" for the field if it is not applicable to the setting. For example, if a user had their Barcode I/P setting set to SERIAL#, and scanned a Serial Number with the value "123456789", the TD? response for an LLT test could be:

```
01,LLT,Pass,500,1.0,135.0,90.0,1.0,1.0,CLOSED,OFF,CLOSED,UL544NP,Ground  
To Line,RMS,ON,123456789,0
```

Note that there is a "0" in the Product Number field because the Barcode I/P setting is SERIAL#.

When the Barcode I/P setting is RUN FILE or OFF, these fields are not included in the TD? and RD x? responses.

**Autostart**

Press the "Autostart" soft key to enable or disable the Autostart feature. When Autostart is enabled, the test will execute as follows:



If the Barcode I/P is set to PRODUCT#, scan the barcode once to input it into the 620L. The 620L will then search for a test file name that matches the product number barcode string. If the 620L finds a match, it will load the file into RAM. When the same product number barcode is scanned a second time, the test will be executed automatically. If 620L does not find a file name that matches the barcode string, the unit will beep – notifying the user that it did not find a matching file name. The test file name is limited to 10 characters. However, if the user names a test file with the maximum 10 characters, this function will still load a test file if the first 10 characters of the product number match the file name.

If the Barcode I/P is set to SER/PROD, scan the serial number once to input it into the 620L. Next, scan the product number. From this point, 620L will operate the same as when the Barcode I/P setting is set to PRODUCT#.

**WARNING**

The Autostart feature will not work with the SERIAL# setting.

The Autostart feature will enable the instrument's output once the product number barcode is scanned a second time when in the PRODUCT# and SER/PROD modes. Do not touch the DUT at any time when using this feature in order to avoid potential shock or serious injury.

**Ethernet Card Settings Commands and Companion Queries**

Command	Name	Value
SIM {1 0} SIM?	Set IP Mode	1=Manual, 0=Auto (DHCP/BOOTP)
SIA <value> SIA?	Set IP Address	Dotted decimal form. Ex. 192.168.1.50
SGA <value> SGA?	Set Gateway IP Address	Dotted decimal form
SSM <value> SSM?	Set Subnet Mask	Dotted decimal form
SDN <value> SDN?	Set Device Name	8 character max, must start with a letter
MAC?	MAC Address Query	Example response: 00:20:4A:8B:B4:30
SBI {0 1 2 3 4} SBI?	Set Barcode Input	0=Off, 1=Ser/Prod, 2=Serial#, 3=Product#, 4=Run File
SAS {1 0} SAS?	Set Autostart	0=Off, 1=On

**Communication Considerations**

- All of the above commands (excluding the query commands) will respond with the 06 hex (6 decimal) Acknowledge (ACK) ASCII control code if the transfer was recognized by the instrument.

- If there was an error with the command string, the instrument will respond with 15 hex (21 decimal), the Not Acknowledge (NAK) ASCII control code.

- However, the presence of this response does not mean that the instrument (in the case of these commands only) completed the command. These commands require a restarting of the hardware that controls the Ethernet Protocols. Because of this, the user must wait before the Ethernet Card will respond to another command. See the table below for the approximate wait times necessary after one of the commands in the table is sent. In addition, the current socket connection between the user's terminal and the Ethernet Card is no longer valid, and the user will need to close their current connection and establish a new one.

**Ethernet Card Settings Command Wait Times**

IP Mode	Command	Wait Time After Command is Sent*
Manual	SIA, SGA, SSM	8 seconds
	SIM 0	14 seconds
Auto	SDN	14 seconds
	SIM 1	8 seconds

\*Wait times are approximate and can vary based on the user's network.

**07 Data Storage Card (DISCONTINUED)**

This option gives the user capabilities for serial communication, barcode scanning, and saving test results onto a USB Flash memory drive.

The Data Storage Card has three input/output ports. These ports are shown in Figure 3.

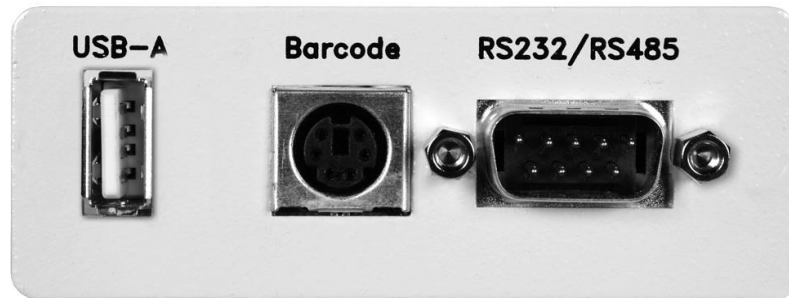

Figure 3.

The USB-A port is used for the connection of the USB Flash memory drive. **Note: Please use the USB Flash memory drive that was supplied with the unit. Proper file transfer can only be guaranteed with the use of this drive.** The port labeled "Barcode" is a PS/2-type connector that is used for the connection of a barcode scanner. The 9-pin D-type subminiature connector labeled "RS232/RS485" is for the connection of the 620L to an RS232 or RS485 communication bus. To configure all of the features of the Data Storage Card, use the Data Card Settings menu.

To navigate to the Data Card Settings menu, select the Setup System softkey from the 620L Main Menu and then select the Data Card Settings softkey in the Setup System menu. A brief description of the settings follows:



### Results Limit

The Results Limit allows the user to receive an alert message on the display of the 620L when the total number of results saved on the Data Storage Card's internal Flash memory has exceeded the predefined limit. This value can be set from the default value of "0" (disables the function) to 100,000. At the conclusion of a test file, if the total results on the internal Flash memory exceed the Results Limit, the following message will display:

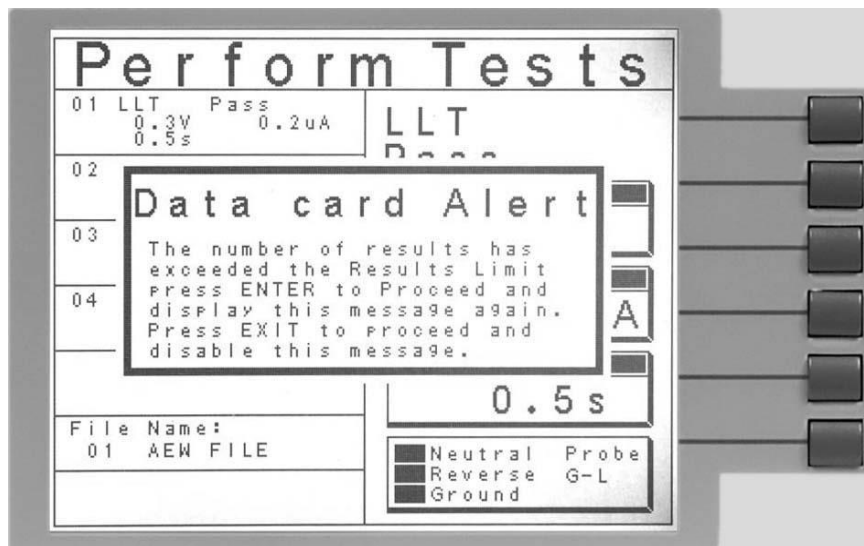

The message gives two options: Pressing Enter will clear the message and display it again at the end of the next test file execution. Pressing Exit will clear the message

and not display it again unless the unit is re-booted, or the user deletes all previous results and the total results are exceeded once more.

### Time Limit

The Results Limit allows the user to receive an alert message on the display of the 620L when any of the results saved on the Data Storage Card's internal Flash memory are older than the predefined setting. The Time Limit can be set to its default value of "0 days" (function is disabled) to 99 days. When the Time Limit is exceeded the following message will appear on the 620L's display:

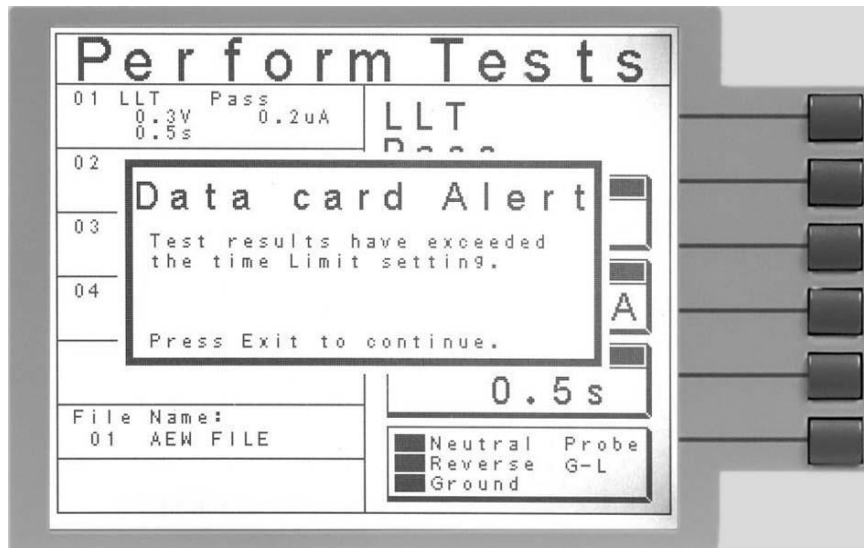

By pressing the EXIT softkey, the message will be cleared and it won't appear again until the unit is re-booted or the Time Limit setting is set to a different value.

### RS485 Address

This setting specifies the RS485 address of the Data Storage Card if the user intends to use the unit in an RS485 network. This address can be set from 1-99. For more information on this interface, see the Serial Port description below.

### Test Result

The Test Result setting determines which type of test result is automatically saved to the Data Storage Card. The possible settings are Pass, Fail, All or None. If the Test Result setting is set to Pass, the Data Storage Card will only save results that resulted in a Pass. If the Test Result setting is set to Fail, the Data Storage Card will only save results that resulted in a Fail. Setting the Test Result setting to All will have the Data Storage Card record all results (pass or fail). If the Test Result setting is set to None, no test result (pass or fail) will be saved to the Data Storage Card's internal memory.

### Serial Port

The serial port can be set to RS232, RS485, or OFF.

### RS232 Interface

When selecting RS232, the protocol for interfacing and communicating with a PC can be found in section **7.1 USB/RS-232 Interface** of this manual.

### RS485 Interface

The RS485 interface of the Data Storage Card is designed to function on a two-wire (half-duplex) RS485 network, i.e. data is received and transmitted differentially on the same pair of wires. The RS485 cabling should be configured as shown:

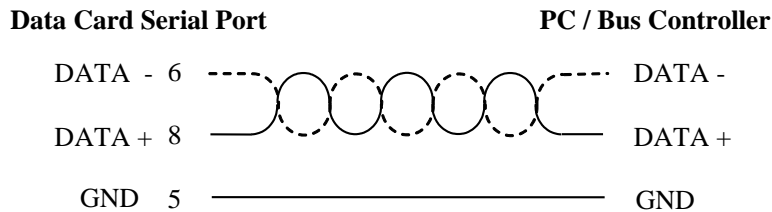

The wire used to connect the DATA signals from the Data Storage Card to the RS-485 network should be twisted pair.

Before sending a command to the RS485 enabled Data Storage Card, the unit that the command is intended for needs to be addressed. To send the address, the following format is used:

*X <RS485 Address><line feed>*

Note that there should be a character space between “X” and the RS485 address. After addressing the unit, the command can be sent. The instrument that was last addressed will receive all subsequent commands sent on the data bus. If the RS485 address specified is “0”, then all RS485 instruments on the bus will receive the command. The command set used for RS485 is the same as the command set for USB/RS-232. See section 7.1 for the USB/RS-232 command set.

When using the RS485 bus and sending the “0” address, the instruments will not respond with the Acknowledge (06H or 6 decimal) or Not Acknowledge (15H or 21 decimal) strings after a command is sent, and will not respond to any Query Commands.

It is also possible to combine the RS485 address and the desired instrument command all in the same string using the following format:

*X <RS485 Address>;<Command><line feed>*

Important note: When communicating with the 620L using the RS485/RS232 port, results are not saved to the Data Storage Card.

### Barcode Input

The Barcode Input setting can be set to SERIAL#, PRODUCT#, SER/PROD, OFF and RUN FILE. When the setting is SERIAL#, PRODUCT# or SER/PROD the user can scan barcodes in the Perform Tests screen before the test is started. When the barcode is scanned, one of the following messages will appear on the display.

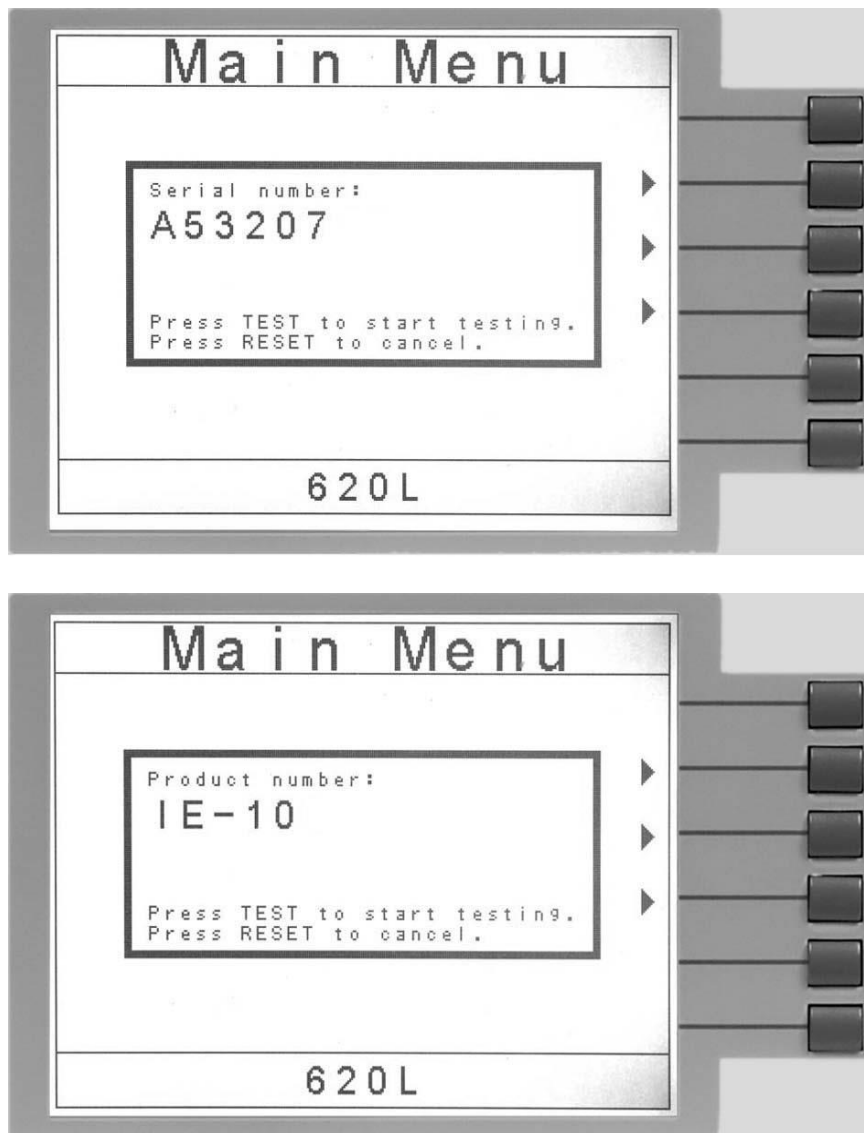

After the barcodes are scanned, pressing TEST will initiate the test sequence. Pressing RESET will abort the TEST sequence.

The Data Storage Card allows for the re-scanning of barcodes if the previously scanned barcode was incorrect. Re-scanning is available in the SERIAL#, PRODUCT# and SER/PROD modes. Anytime before a test is initiated, the user can re-scan a barcode. If the user decides to re-scan barcodes when the Barcode I/P setting is set to SER/PROD, the Data Storage Card will first replace the data in the

Serial Number field, and if the user re-scans another barcode, the Data Storage Card will replace the data in the Product Number field.

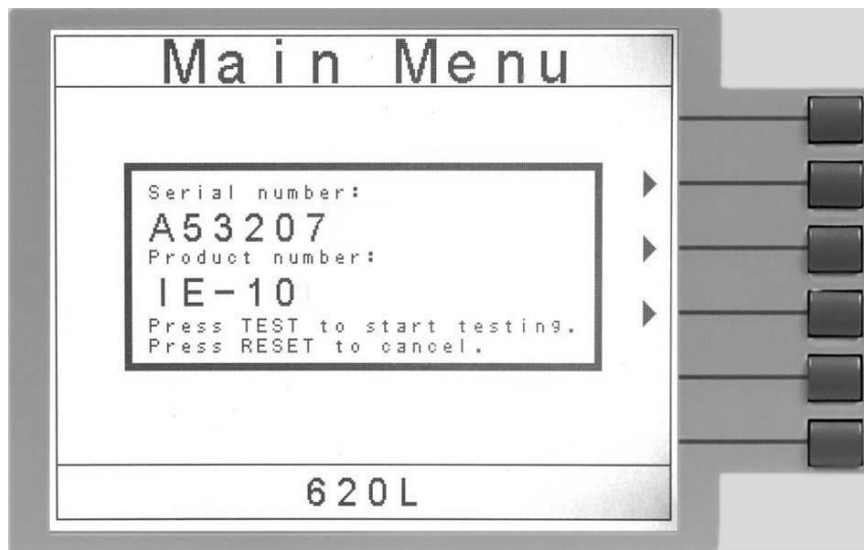

The RUN FILE selection gives the user the ability to automatically load and execute a test file based on what barcode is scanned from the Perform Tests screen.

Using the RUN FILE feature will enable the instrument's output once the barcode is scanned. Do not touch the DUT at any time when using this feature in order to avoid potential shock or serious injury.

To completely enable this feature, the user must name the desired test file for a particular product the exact alpha-numeric code that is on the product's barcode label. For example, if Product A has barcode "123456789", then the test file that the user would like to run when testing Product A should be named "123456789". Upon scanning the barcode, the 620L will immediately execute the test associated with that barcode. The test file name is limited to 10 characters. However, if the user names a test file with the maximum 10 characters, this function will still initiate a test when a product's barcode begins with those first 10 characters even if the barcode has more than 10 characters.

**WARNING** When using certain features of barcoding, the 620L's response to the TD? and RD x? commands will differ slightly to an 620L with the standard USB/RS-232 interface. For all types of tests (LLT, RUN) two fields are added to the end of the standard response when the Barcode I/P setting is set to SERIAL#, PRODUCT# or SER/PROD. The first field contains the Serial Number information and the second field includes the Product Number information. Both fields are included regardless of which of these three modes are selected. The Data Storage Card will simply substitute a "0" for the field if it is not applicable to the setting. For example, if a user had their Barcode I/P setting set to SERIAL#, and scanned a Serial Number with the value "123456789", the TD? response for an LLT test could be:



01,LLT,Pass,500,1.0,135.0,90.0,1.0,1.0,CLOSED,OFF,CLOSED,UL544NP,Ground To Line,RMS,ON,123456789,0

Note that there is a “0” in the Product Number field because the Barcode I/P setting is SERIAL#.

When the Barcode I/P setting is RUN FILE or OFF, these fields are not included in the TD? and RD x? responses.

### Operation

The Data Storage Card Results menu can be viewed by pressing the Results softkey while in the Perform Tests Screen. After doing so the following menu will be shown:

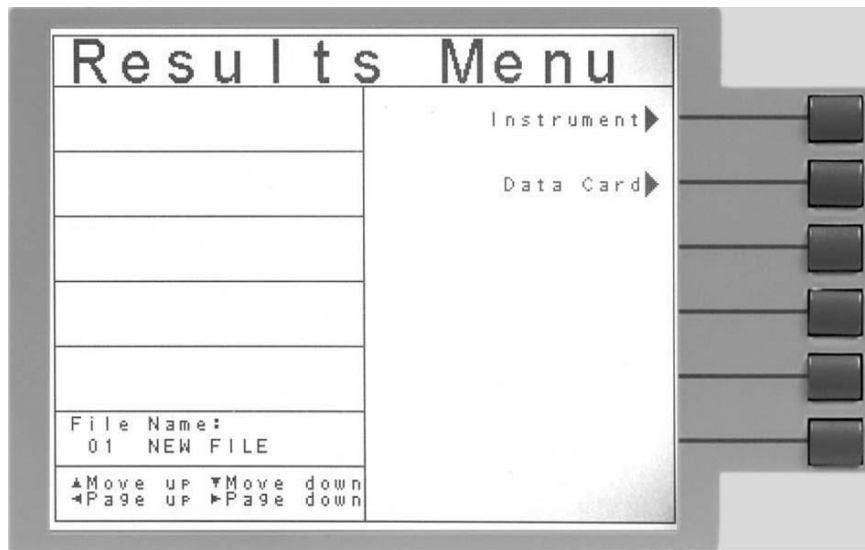

Pressing the softkey labeled Instrument will display the detailed results from the previously executed test file. Pressing the softkey labeled Data Card will display the Data Storage Card Results menu as shown below:

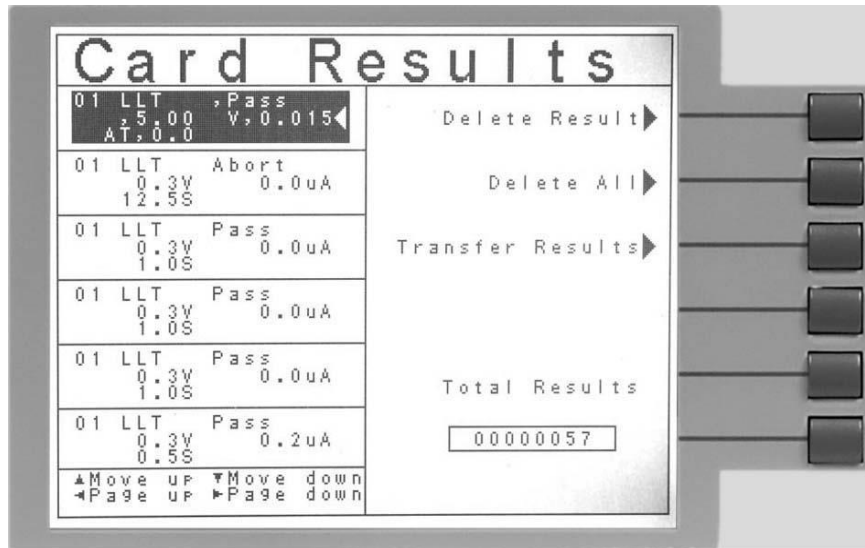

From this menu, the user can view the stored results, delete results, and transfer the results to the external USB Flash memory drive. To navigate through the results use the up, down, left and right softkeys on the 620L front panel. The following message will display if the Delete Result softkey is pressed:



Pressing Enter will verify that the user wants to delete all of the results on the Data Storage Card, and pressing Exit will cancel deleting the results.

The following message will appear if the Delete ALL softkey is pressed:



The following menu will appear if the Transfer Results softkey is pressed:



Follow the instructions on the screen in order to create a name for the file you wish to transfer. There is a limit of 8 characters for the name of the results file. Press the Enter softkey when you have finished entering the file name. After pressing Enter, you will see the following message:

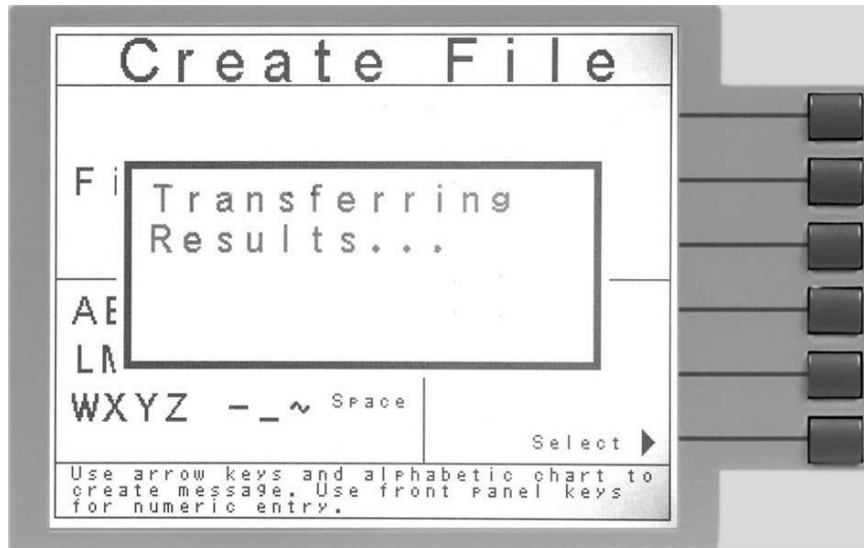

This message will appear on the screen until the Time Remaining reaches 00:00. For each transfer, the Data Storage Card will copy all results in the internal Flash memory regardless if some or all of the results have been transferred before. During each transfer, the Data Storage Card will create a .txt file that will contain the information for all of the results. To view this .txt file, remove the USB Flash memory disk from the Data Storage Card and connect it to a PC with a USB port.

#### *Contents of Results File*

The following is an example entry in the Data Storage Card results file for an arbitrary LLT test:

**00000003,12/13/08,11:07,TEST1,620L,9520014,M01,S01,LLT,Pass,135V,102uA,1.0s**

The following table gives a description of each field for the above LLT test.

<b>Field Contents</b>	<b>Description</b>
00000003	Test Entry in Results File
12/13/08	Date of Test
11:07	Time of Test
TEST1	Test File Name
620L	Model Number of Testing Unit
9520014	Serial Number of Testing Unit
M01	Memory Number of Test File
S01	Step Number
LLT	Test Type
Pass	Test Result
135V	Test Voltage

102uA	DUT Leakage Current
1.0s	Test Dwell Time

The first ten fields of the test result shown above are included in each test result regardless of the test type. The remaining entries are specific to each test type. The following table shows, in order, the information that will be included in each test type's result entry.

RUN	LLT
DUT Voltage	DUT Voltage
DUT Current	DUT Leakage Current
DUT Power	Test Delay Time
Test Dwell Time	
DUT Leakage Current	
DUT Power Factor	

Note: If barcoding is used, the barcoding information will be the final entries in the results file with Serial Number being first and Product Number being second.

### Other Displayed Messages



The above message occurs when the user attempts to transfer results from the Data Storage Card onto the USB Flash memory drive, but there is not enough empty space on the drive to save the file. To save the results file, the user needs to create some empty space on the USB Flash memory drive.

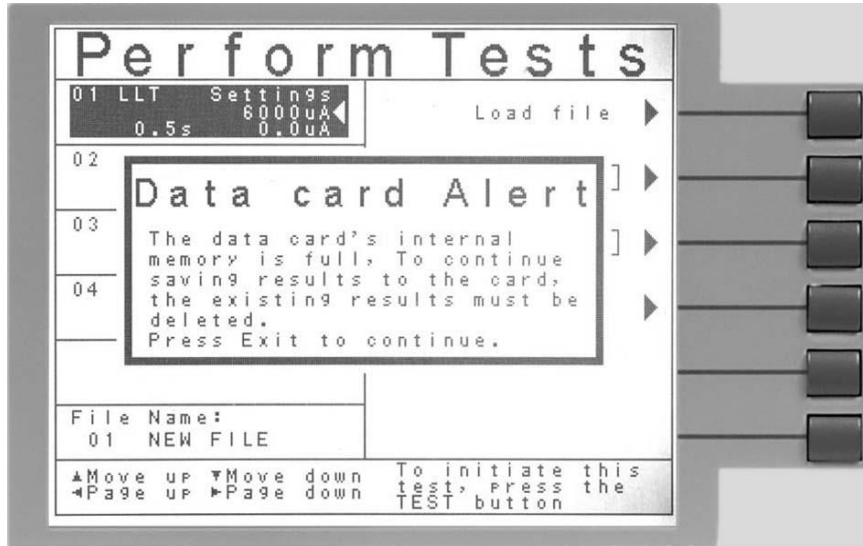

The above message occurs when the total results accumulated on the Data Storage Card exceeds 100,000. The 620L will not allow any more tests to be run unless the user deletes the results currently on the Data Storage Card or changes the Test Result setting in the Data Card Settings menu to NONE. If the Test Result setting is set to NONE, the Data Storage Card will not record test results.



The above message occurs when the user tries to transfer results from the Data Storage Card without the USB Flash memory drive connected. To transfer results, the user needs to have the Flash memory drive connected to the Data Storage Card.

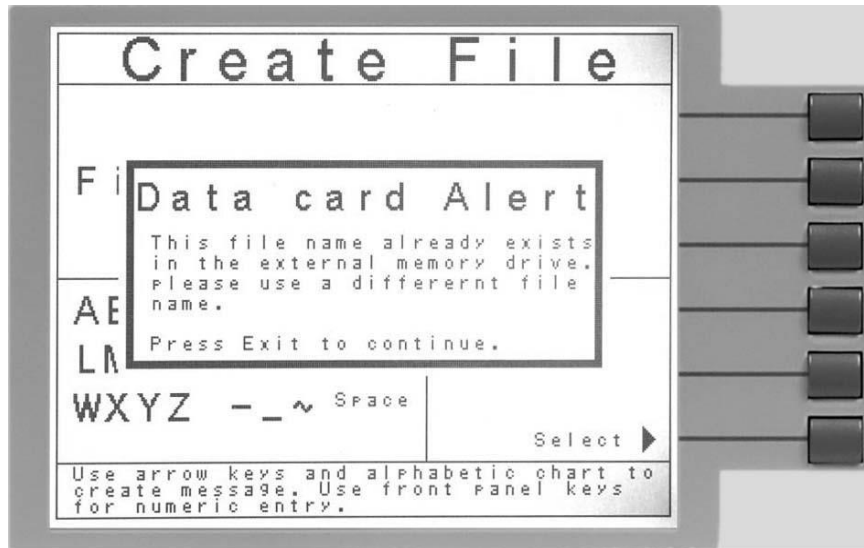

The above message appears when the user attempts to give a name to a results file that already exists on the Data Storage Card.



The above message appears when the total results accumulated by the Data Storage Card exceeds 99,900. This is a warning to the user that the total results are nearing the capacity of the Data Storage Card (100,000). When the total results on the Data Storage Card exceed 100,000, the Data Storage Card will cease saving results. To avoid this, the user can transfer and delete the old test results, or change the Test Result setting in the Data Card Settings menu to NONE. When the Test Result setting is set to NONE, the Data Storage Card will not record test results.



The above message appears when the USB Flash memory drive is write-protected. There are two ways to configure the memory drive as write-protected. One is to set the switch on the side of the memory drive up (towards the drive's connector). The other is to configure it through the drive's properties in Windows.

### 08 Leakage Current Offset Circuit

The 620L Line Leakage Tester allows for an offset of leakage current measurements taken during a line leakage test. The purpose of the LLT Offset is to allow the unit to zero out leakage current associated with the 620L instrument, the instrument leads and any other integrated Associated Research, Inc. instruments. Since there is a capacitive value associated with the Associated Research Inc. instruments, leakage current due to this capacitance factors into the total leakage value displayed during a line leakage test.

The 620L applies a formula for taking an offset into account:

$$\text{Displayed Current} = \sqrt{((\text{Total Leakage Current})^2 - (\text{Offset Current})^2)}$$

The "Total Leakage Current" is the measure of the total leakage current on the system including the 620L, other integrated Associated Research, Inc. instruments and the device under test. The "Offset Current" is the offset current value either specified by the user or calculated automatically by the 620L unit. These two values are used to calculate the actual displayed leakage current measurement. The 620L then calculates the vector sum of the offset value and the total value so that the inherent leakage of the Associated Research, Inc. instruments is excluded from the measurements.



Details regarding the Touch Current Display with LLT Offset specifications are shown below. Note that these accuracies will be the same as the accuracies stated in section **3.1. 620L Functional Specifications** for Touch Current Display (RMS) and Touch Current Display (Peak). These accuracies apply for the specific current range (Ranges 1-6 in Section 3.1):

Leakage Current Offset Circuit		
Leakage Current Offset	Range	0.0-999.9uA
	Resolution	0.1uA
	Accuracy	Same as the Touch Current Specifications
	Please consider the following:	
1. The LLT Leakage meter indicates a value that is calculated using the formula for displayed current shown above.		
2. The Total Leakage can be calculated as: Total Leakage = $\sqrt{((\text{Displayed Current})^2 + (\text{Offset Current})^2)}$		
3. Then the Displayed Current accuracy will include the Total Leakage Current accuracy that is the same as the range of the Touch Current Display (RMS and Peak) accuracy and Offset Accuracy. When the offset value is taken by an automatic offset, the automatic offset accuracy is the same as the relative range of Touch Current Display accuracy.		

### Operation of the Offset

This option adds the offset capability to the line leakage test of the 620L. For detailed information about general test set up procedures, refer to section **4.5. Setting up a Test**. When the LLT Offset Option is installed, the offset parameter will appear along with the other parameters associated with a line leakage test. Utilizing this feature must be done through the Setup Test Parameters window.

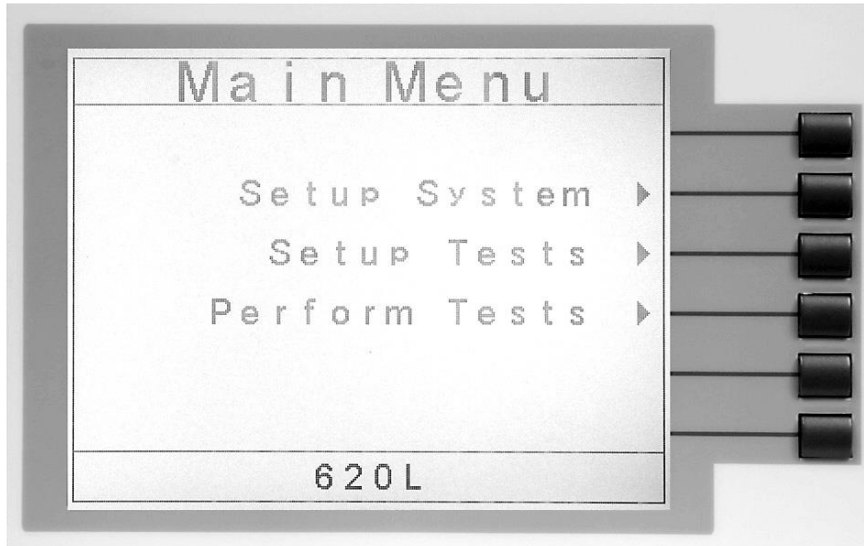

To setup the offset in a line leakage test, press the “Line Leakage Test” soft key from the Setup Tests screen. The Line Leakage Parameter screen will now be displayed. The Line Leakage Parameter Setting screen will appear as follows:

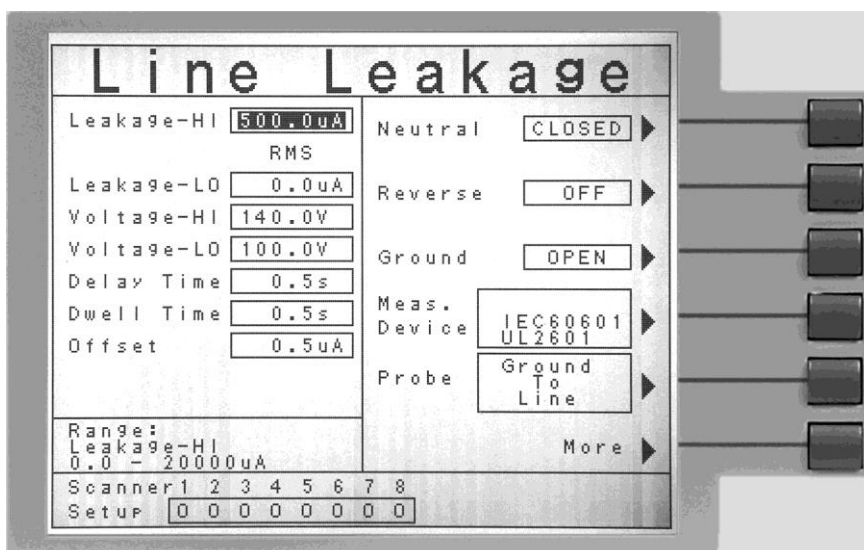

The user must then set the parameters for the line leakage test. When the Offset option is installed, the offset selection can be viewed from the Line Leakage parameters screen.

This is where the user can set an offset. A value can be manually input in the Offset parameter box or the 620L can be used to automatically take a reading. To manually input a value use the arrow keys to scroll down and highlight the “Offset” parameter. Use the number keys to input an offset value. Press the Enter key to set the input value.

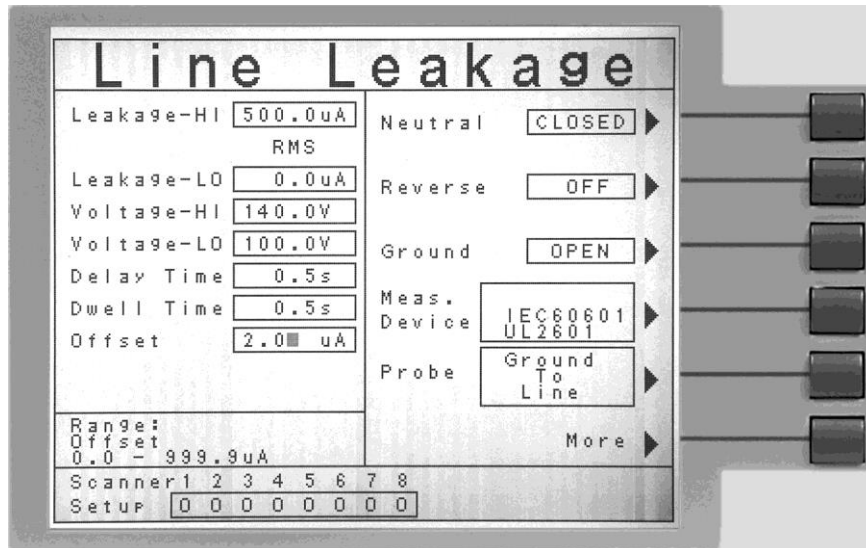

The 620L can also automatically take an offset reading. In order to do this, it is recommended the user attach any components that should be offset from the total measurement. This includes other Associated Research, Inc. instruments working as a system with the 620L (for example, a MedTEST system or an SC6540 scanning matrix). It is recommended the entire system be setup first before taking an automatic reading to account for the leakage associated with all testing units. Do NOT connect the DUT if implementing an offset. For details on how to connect another Associated Research Inc. instrument to the 620L, please refer to Option 3 in this section. For details on how to connect an SC6540 scanner to the 620L, please refer to Option 4 in this section.

From the Line Leakage Parameter screen, use the arrow keys to scroll down and highlight the “Offset” parameter. A message will come up below the Offset parameter box: “Press TEST key for automatic offset setting.” Pushing the TEST key will allow the 620L to automatically read the leakage of the system.

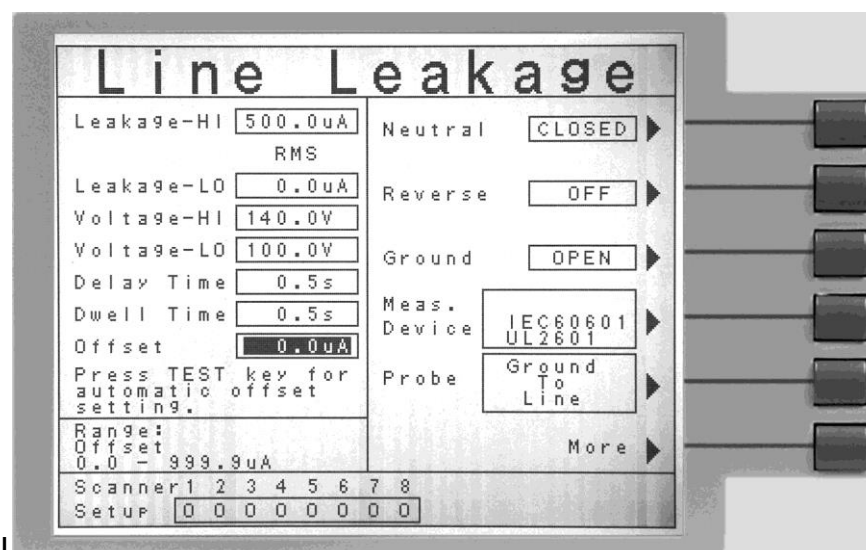

It is recommended that the offset be performed for each line leakage test. This is to account for inherit leakage readings on the system under the various fault conditions. The offset is not universal for the line leakage tests so a reading must be taken on each individual line leakage test.

There is a set of commands associated with the LLT Offset when this option is enabled.

### LLT Offset Commands and Companion Queries

COMMAND	NAME	DESCRIPTION
ADD <test,p1,p2,p3...>	Adds all parameters	
ELO <value> ELO?	Set LLT Offset Value	0.0 - 999.9uA
SAO <value>	Set Automatic LLT Offset Value	0.0 - 999.9uA
LS?	List Step Parameters	
LS <step number>?	List Step Parameters by step number	step number = 1-30

The LS? command and ADD command will function the same as the standard 620L but there is an extra parameter for the LLT Offset value included in the list of parameters as shown in the table below. The LLT Offset is added as the 7<sup>th</sup> parameter in the sequence:

	LLT
1	Leakage-HI
2	Leakage-LO
3	Voltage-HI
4	Voltage-LO
5	Delay Time
6	Dwell Time
7	LLT Offset
8	Neutral (OPEN/CLOSED)
9	Reverse (ON/OFF)
10	Ground (OPEN/CLOSED)
11	Meas. Device (UL544NP/UL544P/IEC601-1 UL2601-1/UL1563/IEC1010 UL3101 UL1950/EXTERNAL)

<b>12</b>	Probe (Ground To Line/ Probe-HI to Line/Probe-HI To Probe-LO)
<b>13</b>	Extended Meters (ON/OFF)
<b>14</b>	AC/DC (AC+DC,AC,DC)
<b>15</b>	Ranging Mode (AUTO,MANUAL)
<b>16</b>	Leakage Mode (Peak/RMS)
<b>17</b>	Continuous (ON/OFF)
<b>18</b>	Scanner

For example, if a test with the LLT Offset option enabled is set in the unit, the LS? command will display the following parameters:

2,LLT,6000,0.0,100.0,0.0,0.5,0.5,0.1,CLOSED,OFF,CLOSED,UL544NP,Ground to Line,OFF,AC+DC,AUTO,RMS,OFF

This corresponds to:

Step Number,Test Type,Leakage-HI,Leakage-LO,Voltage-HI,Voltage-LO,Delay,Dwell,LLT Offset,Neutral,Reverse,Ground,Measuring Device,Probe Configuration,Extended Meters,AC/DC Mode,Ranging Mode,Leakage Mode,Continuous,Scanner Setting

Another example for the ADD command is shown below. This would be used to add a line leakage test with the following parameters:

ADD LLT,6000,0.0,100.0,0.0,0.5,0.5,3.6,CLOSED,OFF,CLOSED,UL544NP,Ground to Line,OFF,AC+DC,AUTO,RMS,OFF,HLOOHLL

This corresponds to adding an LLT test:

ADD Test Type,Leakage-HI,Leakage-LO,Voltage-HI,Voltage-LO,Delay,Dwell,LLT Offset,Neutral,Reverse,Ground,Measuring Device,Probe Configuration,Extended Meters,AC+DC Mode,Ranging Mode,Leakage Mode,Continuous,Scanner Setting

**NOTE on using this feature optimally:**

The formula applied to this option is only accurate if the phase shift between the “620L system” and the DUT is 90 degrees. This is because the formula for negating the inherit leakage current on the 620L system is a vector sum calculation. It should be noted that the term “620L system” refers to not only the 620L unit but also any other Associated Research, Inc. safety tester integrated with the 620L unit as well as any fixtures the end user may include to the system. Other instruments and fixtures will introduce extra capacitance and resistance to the network and will change the relationship of the phase angle between the 620L system and the DUT.

The following example illustrates this point:

Consider the network in Figure 1 as a simulation for a 620L system and DUT. The network consists of a 307.3pF capacitor to represent the capacitance of the 620L system. This is in parallel with a 5MΩ resistor to represent the DUT. The voltage source is generating 120V at 60Hz.

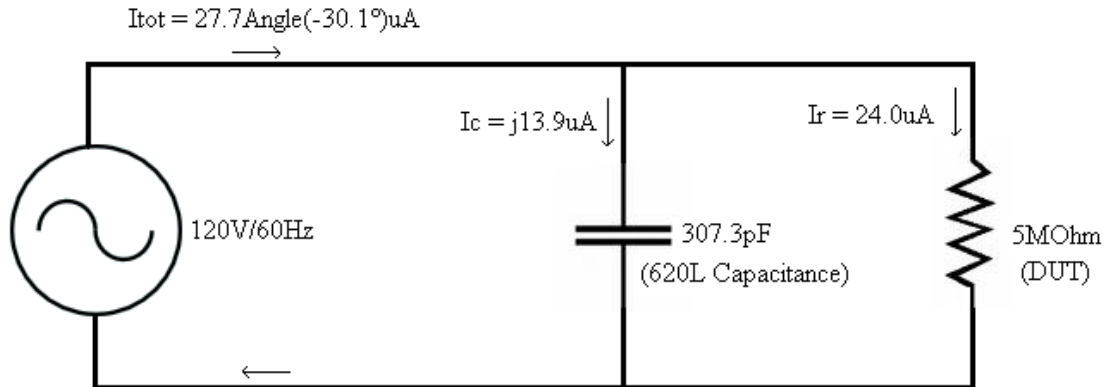

Figure 1

The two components have the same potential applied across them. Each element will have its own associated current. Current flowing through the capacitor will be denoted as  $I_c$  and current flowing through the resistor will be denoted as  $I_r$ . The vector summation of these currents is the total current in the system,  $I_{tot}$ . The theoretical calculations are shown below:

$$I_r = V/R = 120V/5,000,000\Omega = 24.0\mu A$$

Current through the capacitor requires an extra calculation of the capacitive reactance:

Capacitive Reactance =  $X_c = 1/(2\pi fC)$  where  $f$  is frequency and  $C$  is the capacitance.

$$X_c = 1/(2\pi*(60Hz)*(307.3pF)) = 8,631,898\Omega$$

$$\text{So } I_c = V/X_c = 120V/8,631,898\Omega = j13.9\mu A.$$

Then the total current  $I_{tot} = 24.0\mu A - j13.9\mu A$ . This breaks down into a magnitude and phase angle:

$$\text{Magnitude of } I_{tot} = |I_{tot}| = \sqrt{(24.0^2 + 13.9^2)} = 27.7\mu A$$

$$\text{Phase Angle} = \text{Angle}(I_{tot}) = \text{Tan}^{-1}(-j13.9/24.0) = -30.1^\circ$$

$$\text{Therefore } I_{tot} = 27.7\text{Angle}(-30.1)\mu A$$

Using the Offset feature on this network, the 620L displays the following:

**Offset = 13.9uA**

The test is then run. The 620L displays the following:

**Displayed Current = 24.0uA**

This is a result of the vector sum calculation:  $24.0\mu\text{A} = \sqrt{((27.7\mu\text{A})^2 - (13.9\mu\text{A})^2)}$

The Displayed Current is the current flowing through the resistor. This is because the phase angle of the 620L system can be considered to be purely capacitive ( $-90^\circ$ ) and the phase angle of the resistance is  $0^\circ$ . Since the phase angle between the 620L system leakage current and the DUT leakage current is  $90^\circ$ , the LLT Offset works optimally for this application.

If the phase shift between the 620L system and the DUT is not  $90^\circ$ , the Displayed Current value will not be a valid representation of the leakage current flowing through the DUT. Consider a second test circuit. This test circuit is shown in Figure 2. The 620L system is modeled by the 307.3pF capacitor. In this case, the DUT is modeled by the parallel combination of a 1nF capacitor and a 5M $\Omega$  resistor.

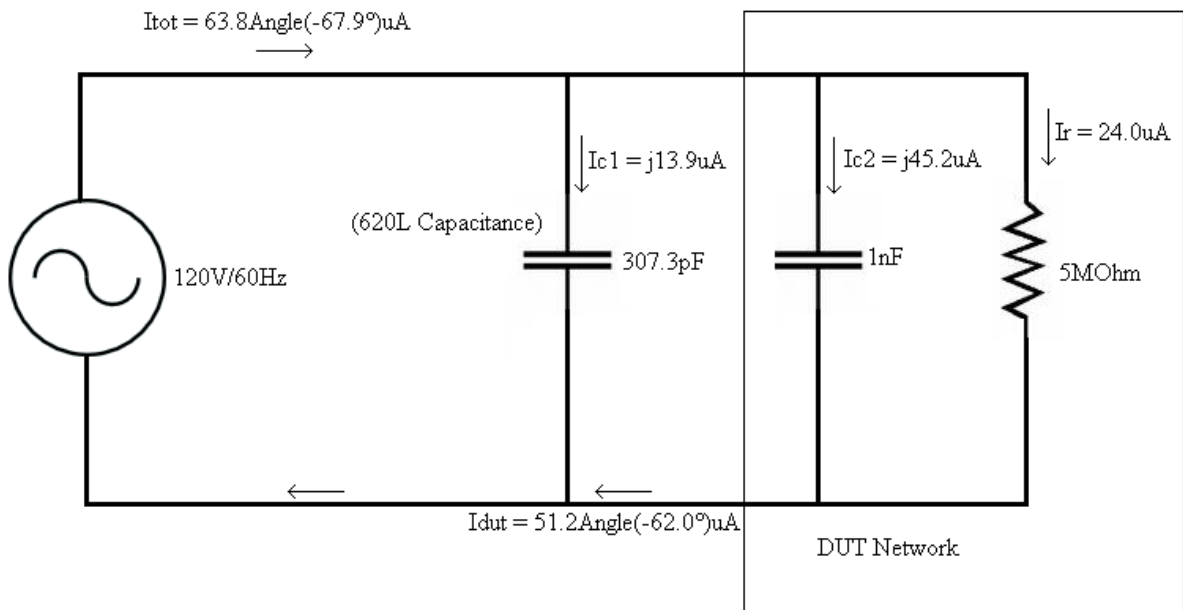

Figure 2

From the calculations of the first circuit network, it is known that the capacitive reactance of the 307.3pF capacitance is  $X_{c1} = 8,631,898\Omega$ . The capacitive reactance of the 1nF capacitor is shown below:

$$X_{c2} = 1/(2\pi f C_2) = 1/(2\pi * (60\text{Hz}) * (1\text{nF})) = 2,652,582 \Omega$$

The current through each branch of the network:

$I_r = 120V/5,000,000 \Omega = 24.0\mu A$  is the current through the 5M $\Omega$  resistor.

$I_{c1} = 120V/8,631,898 \Omega = j13.9\mu A$  is the current through the 307.3 $\mu F$  capacitor.

$I_{c2} = 120V/2,652,582 \Omega = j45.2\mu A$  is the current through the 1nF capacitor.

The current flowing through the DUT is a combination of the current flowing through  $I_{c2}$  (the 1nF capacitor) and the resistor:

$I_{dut} = (24.0\text{Angle}(0^\circ) + 45.2\text{Angle}(-90^\circ))\mu A = (24.0 - j45.2)\mu A = 51.2\text{Angle}(-62.0^\circ)\mu A$

The total current is then  $I_{tot} = (24.0\text{Angle}(0^\circ) + 13.9\text{Angle}(-90^\circ) + 45.2\text{Angle}(-90^\circ))\mu A$

$I_{tot} = (24.0 - j13.9 - j45.2)\mu A = (24.0 - j59.1)\mu A$

Thus  $I_{tot} = 63.8\text{Angle}(-67.9^\circ)\mu A$

Once again the Offset feature is implemented to offset the current flowing through the capacitance of the 620L system:

**Offset = 13.9 $\mu A$**

The test is then run. The 620L will then calculate the displayed current value:

**Displayed Leakage = 62.3 $\mu A$**

This is a result of the vector sum calculation:  $62.3\mu A = \sqrt{(63.8\mu A)^2 - (13.9\mu A)^2}$

However, the calculated value of the current flowing through the DUT is 51.2 $\mu A$ . In the first circuit the current through the DUT has a phase angle of 0 $^\circ$  because it consists of a pure resistance. The introduction of the 1nF capacitor to the DUT in the second circuit causes the phase shift between the 620L system and the DUT to change from 90 $^\circ$  to 62 $^\circ$  ( $I_{dut} = 51.2\text{Angle}(-62.0^\circ)\mu A$ ). As a result, the calculated value for displayed current does not match the theoretical value calculated above.

The above example illustrates that the phase relationship between the offset current associated with the 620L system and the current flowing through the DUT is critical. This phase difference must be 90 $^\circ$  in order for the vector subtraction to calculate displayed current to represent the true value of the leakage current flowing through the DUT.



## 9. CALIBRATION

### DID YOU KNOW?

This instrument has been fully calibrated at the factory in accordance to our published specifications and with standards traceable to the National Institute of Standards & Technology (NIST).

You will find in this manual a copy of the "Certificate of Calibration". It is recommended that you have this instrument recertified at least once per year. Associated Research, Inc. recommends you use "Calibration Standards" that are NIST traceable or traceable to agencies recognized by NIST to keep this instrument within published specifications. Unless necessary, do not recalibrate the instrument within the first 12 months.

End user metrology standards or practices may vary. These metrology standards determine the measurement uncertainty ratio of the calibration standards being used. Calibration adjustments can only be made in the Calibration mode and calibration checks or verifications can only be made while operating in Test mode.

- **Note:** Verification should be performed before and after calibration. Calibration effects will only be noticeable after exiting calibration mode.

### 9.1. Warranty Requirements

Associated Research, Inc. offers a standard three-year manufacturer's warranty. This warranty can be extended an additional two years provided that the instrument is returned each year to Associated Research, Inc. for its annual recertification. In order to be eligible for the extended warranty instruments must be returned to Associated Research, Inc. for certification service at least once every twelve months.

A return material authorization number (RMA) must be obtained from Associated Research, Inc. before returning this instrument for calibration. To obtain an RMA number or for information regarding our warranty, please contact our customer support representatives at 1-800-858-TEST (8378).

#### Required Calibration Equipment

- Adjustable AC power supply, 0-277 Volts, 10kVA
- Adjustable AC function generator, 20mV resolution
- Adjustable DC power supply, 0.032-30 Volts
- 0-277 VAC voltmeter
- 0-30 VDC voltmeter
- 0-40 AAC ammeter
- 0-4 mADC ammeter
- 0-10kW power meter
- 5Ω @ 200 Volt load resistor (40A, 10kVA)
- 60Ω @ 240 Volt load resistor (4A, 1kVA)

## 9.2. Calibration Initialization

Press and hold the calibration key on the rear panel with a pen, pencil or small screwdriver while powering ON the 620L. The 620L enters calibration mode after the power on sequence is complete.

The Calibration screen is separated into three sections. The left half of the screen lists all of the calibration points necessary for an accurate calibration of the instrument. The right half of the screen is split into two smaller screens. The upper right section of the screen displays meter and load information required to perform the selected calibration. The lower right section of the screen contains prompts that will help guide you through the calibration process.

### Selecting Specific Calibration Points

When the calibration is initialized, the first calibration point is automatically selected. The calibration is set up so that as each calibration point is completed the highlighted area will automatically scroll to the next calibration point.

To manually select calibration points, use the up and down arrows to scroll the highlighted area to the desired calibration point. The load/meter screen and prompt screens will automatically update for the calibration point selected.

### Calibration of Parameters

Each calibration point requires different loads, standards and process. As each point is selected, the load/meter screen and prompt screens will display the meter, load and process information required to complete the calibration process for the selected point.

### Hardware calibration

This paragraph covers the hardware calibration procedure for the LLT Leakage 8.00mA – 20.00mA range. The hardware calibration is required to be performed prior to the standard software calibration of the LLT MD Volts x0.1 range only when the Analog Control Board ANG7630 replaces.

Required Measurement Standard:

Wideband Voltmeter 100 kHz capable of measuring to 20 VAC

Sine Wave Generator 100 Hz to 100 kHz capable

Procedure:

Connect the Probe-HI and Probe-LO leads to output of the Sine Wave Generator and in parallel with Wideband Voltmeter.

Select the LLT step and set Leakage-HI = 20.00mARMS in manual ranging mode with filter set to AC+DC, Dwell Time = 0.0s, Measuring Device to “Frequency Check”, and Probe configuration to “Probe-HI To Probe-LO”.

Set the output frequency of the Sine Wave Generator to 100 kHz.

Adjust output of the Sine Wave Generator to 19.00VRMS or to maximum that generator provides. To meet required accuracy the Voltage should be bigger than 5.00VRMS. Control the output voltage with the standard Wideband Voltmeter. Write down the RMS Leakage current that the 620L meter indicates.

Change the output frequency of the Sine Wave Generator to 100 Hz and adjust the output voltage to the same value.

Adjust the VR1 on the 620L to have the Leakage current as close as possible to the value recorded above.

### 9.2.1. Calibration of Run Test Voltage

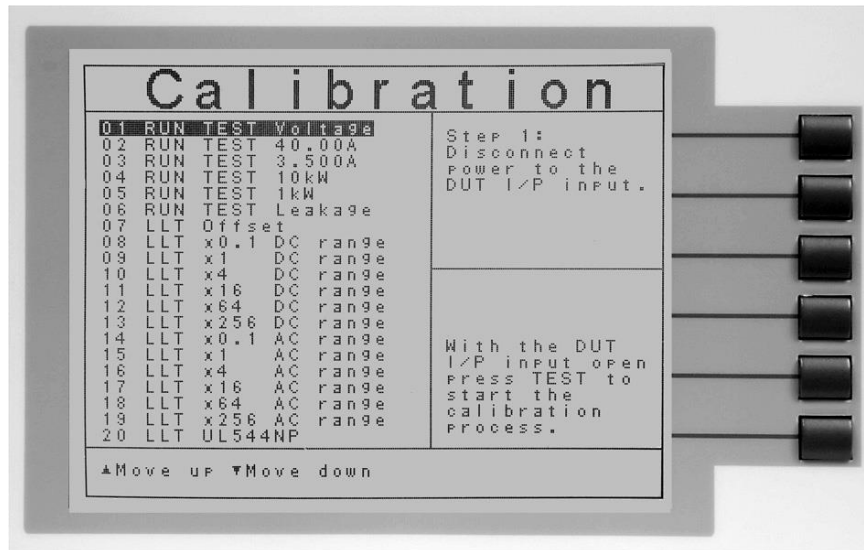

Upper Right Screen Load/Meter	Lower Right Screen Prompt	Lower Right Screen Prompt (Cal. Active)
Step 1: Disconnect power to the DUT I/P input.	With the DUT I/P input open, press TEST to start the calibration process.	Automatic Calibration Processing.
Step 2: Connect 250VAC and a standard voltmeter to the DUT I/P input.	Press TEST to start the calibration process.	Enter Standard Voltage Reading.

Press the TEST button to activate the calibration. After the calibration is activated, the lower right screen will change to the text indicated in the table above (**Cal. Active**). Read the measurement from your standard and enter it using the numeric keypad. You may now store the new calibration number by pressing the ENTER key or escape by pressing the EXIT key or the RESET button.

### 9.2.2. Calibration of Run Test Current

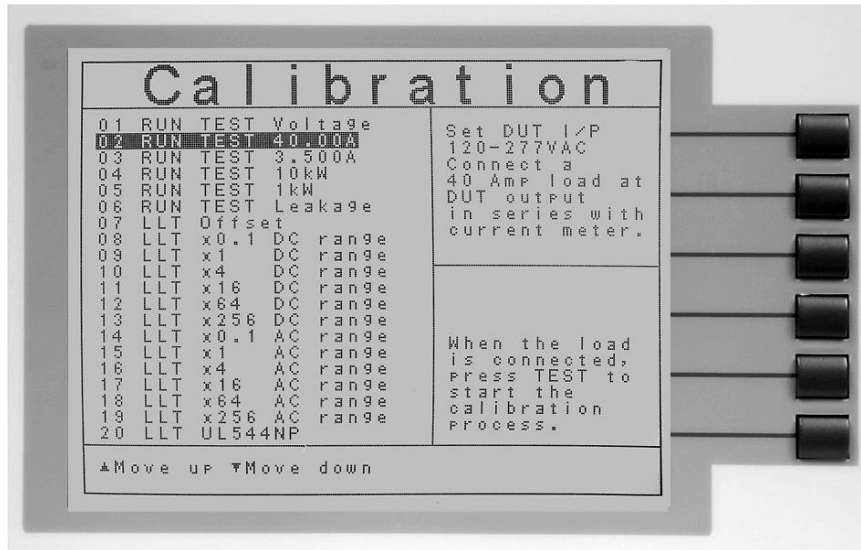

Upper Right Screen Load/Meter	Lower Right Screen Prompt	Lower Right Screen Prompt (Cal. Active)
Set DUT I/P 120-277VAC. Connect a 40 Amp load at DUT output in series with current meter.	When the load is connected, press TEST to start the calibration process.	Enter Standard Current Reading.

Press the TEST button to activate the calibration. After the calibration is activated, the lower right screen will change to the text indicated in the table above (**Cal. Active**). Read the measurement from your standard and enter it using the numeric keypad. You may now store the new calibration number by pressing the ENTER key or escape by pressing the EXIT key or the RESET button.

### 9.2.3. Calibration of Run Test Current

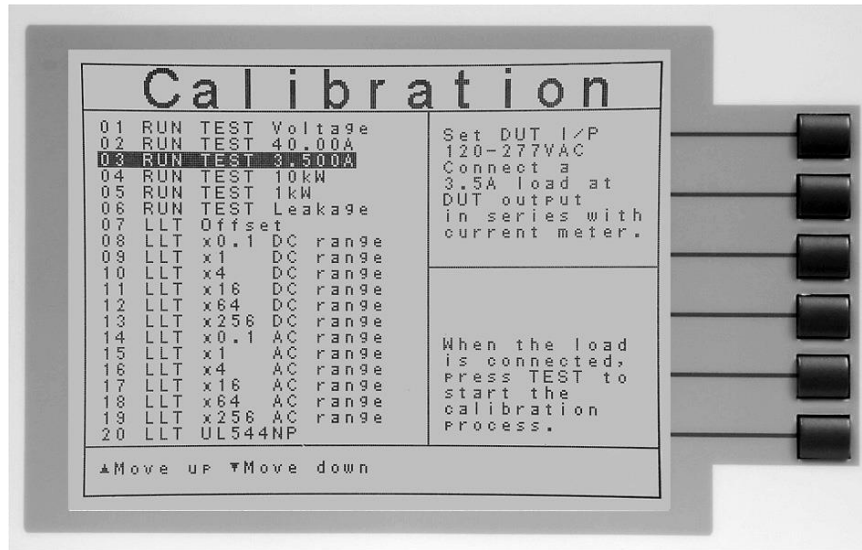

Upper Right Screen Load/Meter	Lower Right Screen Prompt	Lower Right Screen Prompt (Cal. Active)
Set DUT I/P 120-277VAC. Connect a 3.5 Amp load at DUT output in series with current meter.	When the load is connected, press TEST to start the calibration process.	Enter Standard Current Reading.

Press the TEST button to activate the calibration. After the calibration is activated, the lower right screen will change to the text indicated in the table above (**Cal. Active**). Read the measurement from your standard and enter it using the numeric keypad. You may now store the new calibration number by pressing the ENTER key or escape by pressing the EXIT key or the RESET button.

### 9.2.4. Calibration of Run Test Power

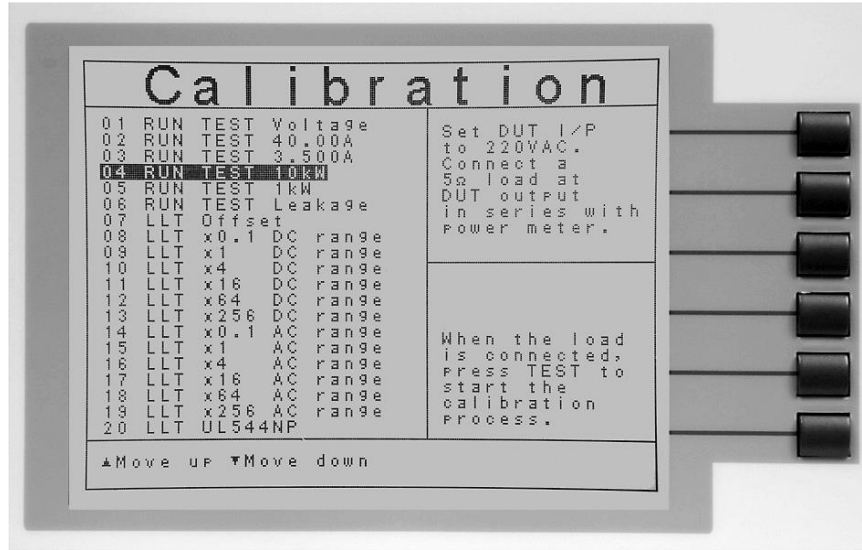

Upper Right Screen Load/Meter	Lower Right Screen Prompt	Lower Right Screen Prompt (Cal. Active)
Set DUT I/P voltage to 220VAC. Connect a 5Ω load. Connect power meter in series with the DUT.	When the load is connected, press TEST to start the calibration process.	Enter Standard Power Reading.

Press the TEST button to activate the calibration. After the calibration is activated, the lower right screen will change to the text indicated in the table above (**Cal. Active**). Read the measurement from your standard and enter it using the numeric keypad. You may now store the new calibration number by pressing the ENTER key or escape by pressing the EXIT key or the RESET button.

### 9.2.5. Calibration of Run Test Power

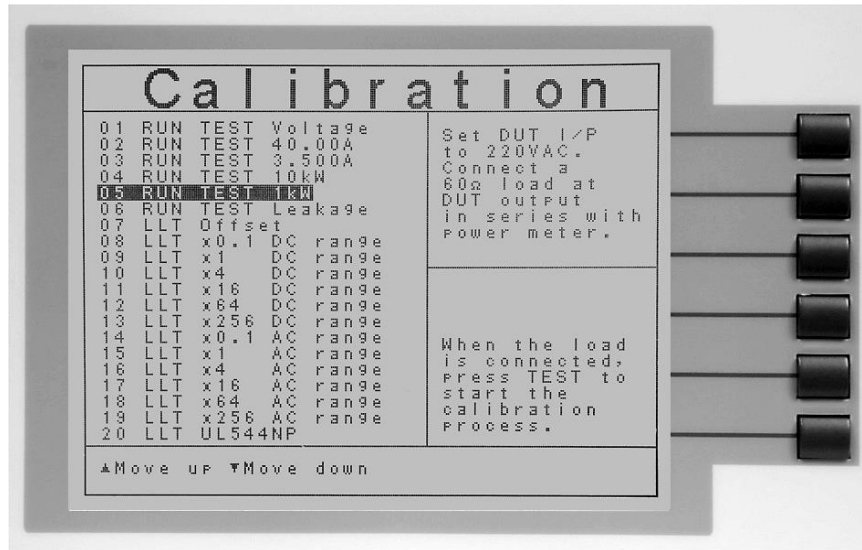

Upper Right Screen Load/Meter	Lower Right Screen Prompt	Lower Right Screen Prompt (Cal. Active)
Set DUT I/P voltage to 220VAC. Connect a 60Ω load. Connect power meter in series with the DUT.	When the load is connected, press TEST to start the calibration process.	Enter Standard Power Reading.

Press the TEST button to activate the calibration. After the calibration is activated, the lower right screen will change to the text indicated in the table above (Cal. Active). Read the measurement from your standard and enter it using the numeric keypad. You may now store the new calibration number by pressing the ENTER key or escape by pressing the EXIT key or the RESET button.

### 9.2.6. Calibration of Run Test Leakage

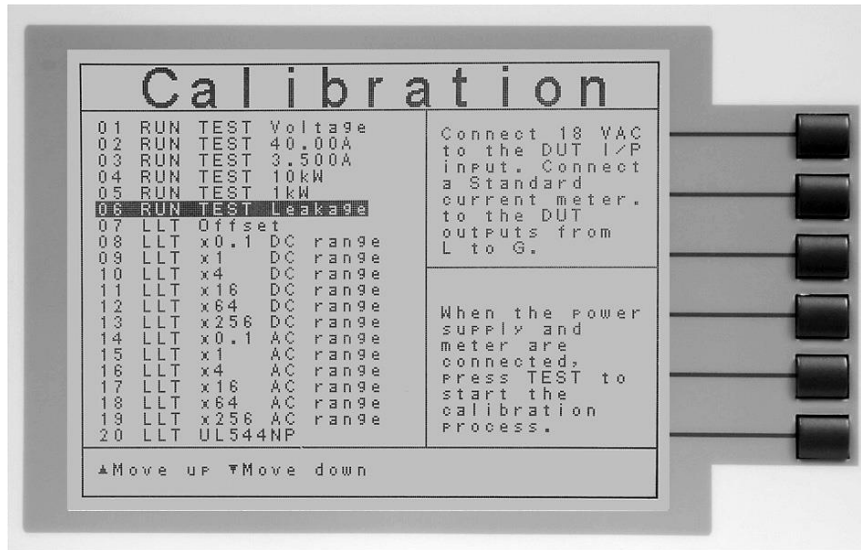

Upper Right Screen Load/Meter	Lower Right Screen Prompt	Lower Right Screen Prompt (Cal. Active)
Connect 18 VAC to the DUT I/P input. Connect a standard current meter to the DUT outputs from L to G.	When the power supply and meter are connected, press TEST to start the calibration process.	Enter Standard Current Reading.

Press the TEST button to activate the calibration. After the calibration is activated, the lower right screen will change to the text indicated in the table above (**Cal. Active**). Read the measurement from your standard and enter it using the numeric keypad. You may now store the new calibration number by pressing the ENTER key or escape by pressing the EXIT key or the RESET button.



### 9.2.7. Calibration of LLT MD V-Offset

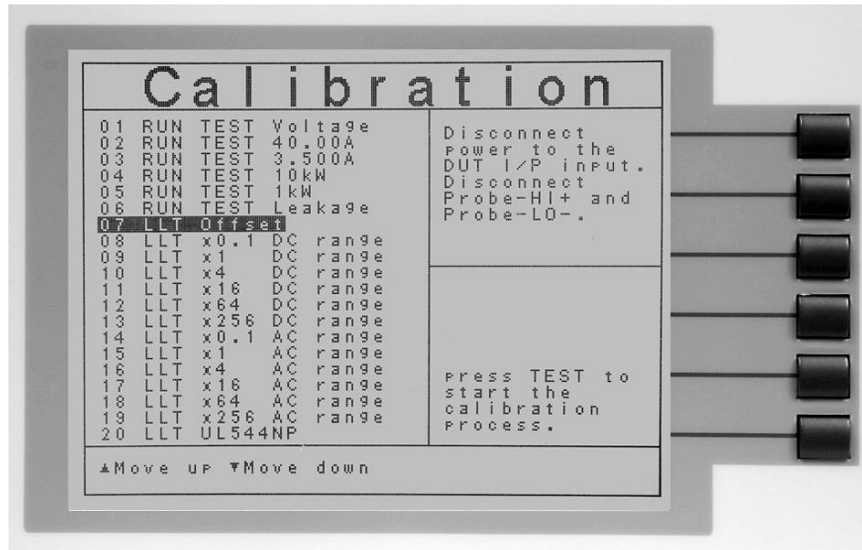

Upper Right Screen Load/Meter	Lower Right Screen Prompt	Lower Right Screen Prompt (Cal. Active)
Disconnect power to the DUT I/P input. Disconnect Probe-HI+ and Probe-LO-.	When the leads are disconnected, press TEST to start the calibration process.	Automatic Calibration Processing.

Press the TEST button to activate the calibration. After the calibration is activated, the lower right screen will change to the text indicated in the table above (**Cal. Active**).

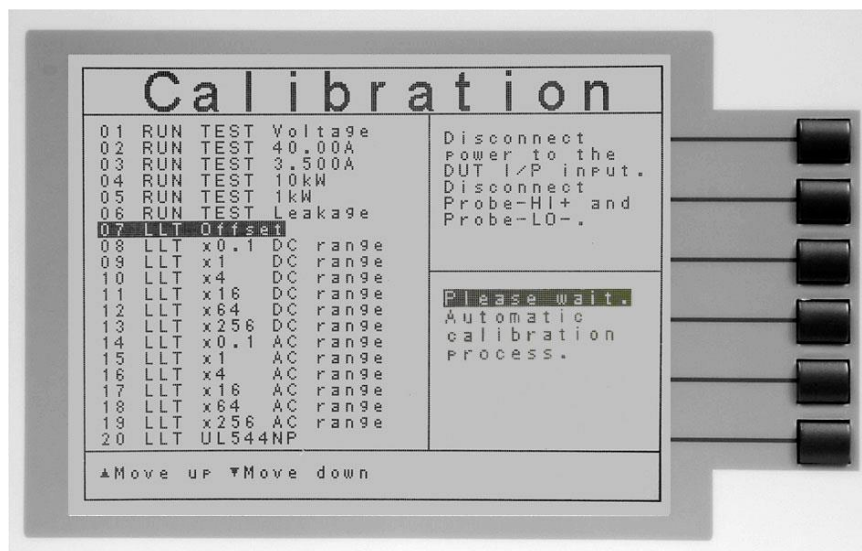

This calibration is automatic and does not require data entry.

### 9.2.8. Calibration of LLT MD Volts DC x 0.1

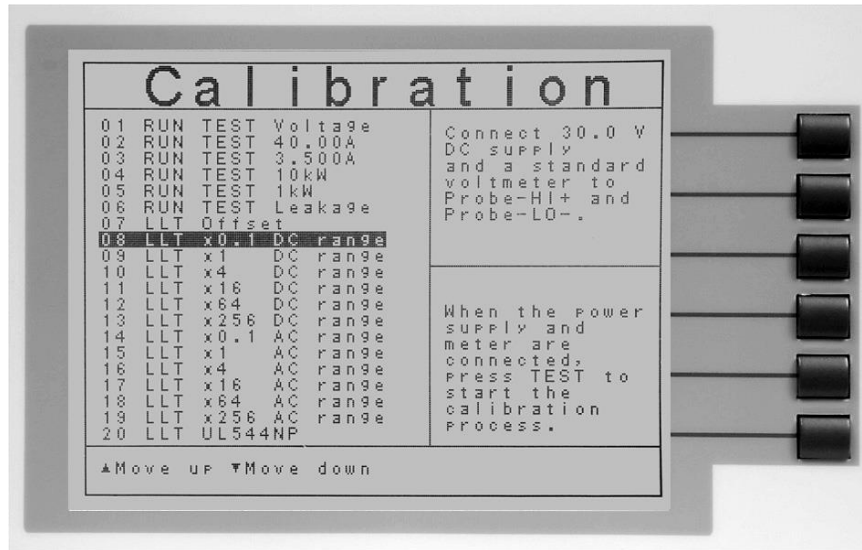

Upper Right Screen Load/Meter	Lower Right Screen Prompt	Lower Right Screen Prompt (Cal. Active)
Connect 30.0VDC and a voltmeter to Probe-HI + and Probe-LO -.	When the power supply and meter are connected, press TEST to start the calibration.	Enter Standard Voltage Reading.

Press the TEST button to activate the calibration. After the calibration is activated, the lower right screen will change to the text indicated in the table above (**Cal. Active**). Read the measurement from your standard and enter it using the numeric keypad. You may now store the new calibration number by pressing the ENTER key or escape by pressing the EXIT key or the RESET button.

### 9.2.9. Calibration of LLT MD Volts DC x 1

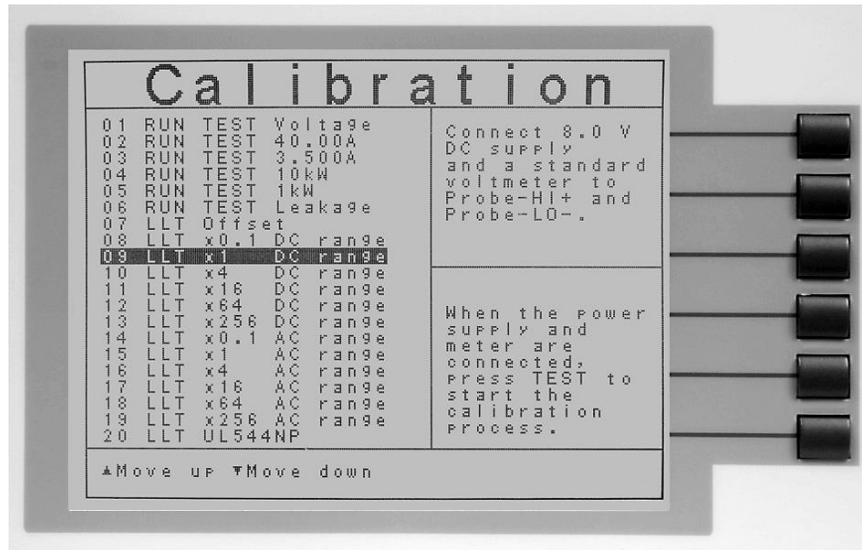

Upper Right Screen Load/Meter	Lower Right Screen Prompt	Lower Right Screen Prompt (Cal. Active)
Connect 8.0VDC and a voltmeter to Probe-HI + and Probe-LO -.	When the power supply and meter are connected, press TEST to start the calibration.	Enter Standard Voltage Reading.

Press the TEST button to activate the calibration. After the calibration is activated, the lower right screen will change to the text indicated in the table above (**Cal. Active**). Read the measurement from your standard and enter it using the numeric keypad. You may now store the new calibration number by pressing the ENTER key or escape by pressing the EXIT key or the RESET button.

### 9.2.10. Calibration of LLT MD Volts DC x 4

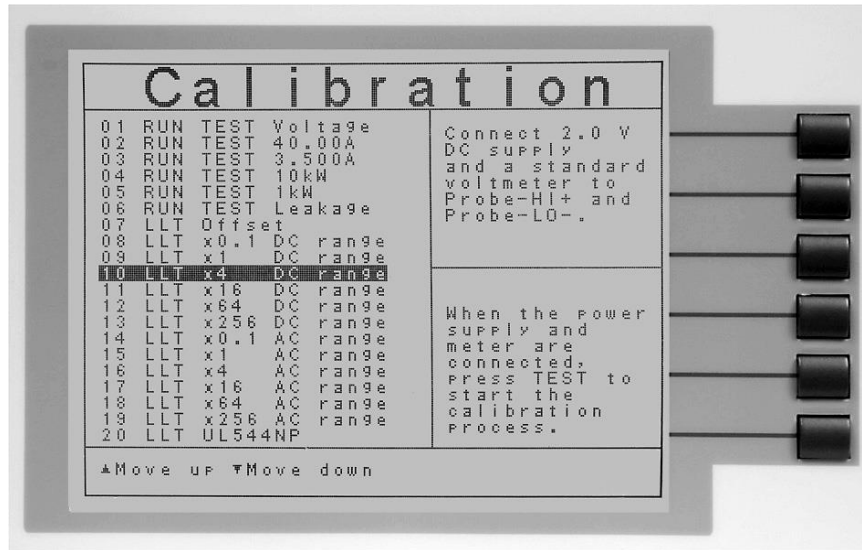

Upper Right Screen Load/Meter	Lower Right Screen Prompt	Lower Right Screen Prompt (Cal. Active)
Connect 2.0VDC and a voltmeter to Probe-HI + and Probe-LO -.	When the power supply and meter are connected, press TEST to start the calibration.	Enter Standard Voltage Reading.

Press the TEST button to activate the calibration. After the calibration is activated, the lower right screen will change to the text indicated in the table above (**Cal. Active**). Read the measurement from your standard and enter it using the numeric keypad. You may now store the new calibration number by pressing the ENTER key or escape by pressing the EXIT key or the RESET button.

### 9.2.11. Calibration of LLT MD Volts DC x 16

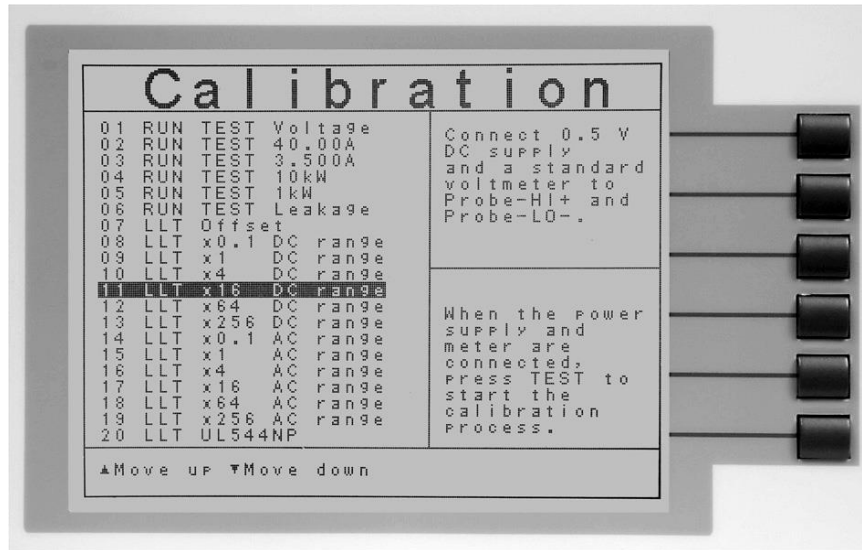

Upper Right Screen Load/Meter	Lower Right Screen Prompt	Lower Right Screen Prompt (Cal. Active)
Connect 0.5VDC and a voltmeter to Probe-HI + and Probe-LO -.	When the power supply and meter are connected, press TEST to start the calibration.	Enter Standard Voltage Reading.

Press the TEST button to activate the calibration. After the calibration is activated, the lower right screen will change to the text indicated in the table above (**Cal. Active**). Read the measurement from your standard and enter it using the numeric keypad. You may now store the new calibration number by pressing the ENTER key or escape by pressing the EXIT key or the RESET button.

### 9.2.12. Calibration of LLT MD Volts DC x 64

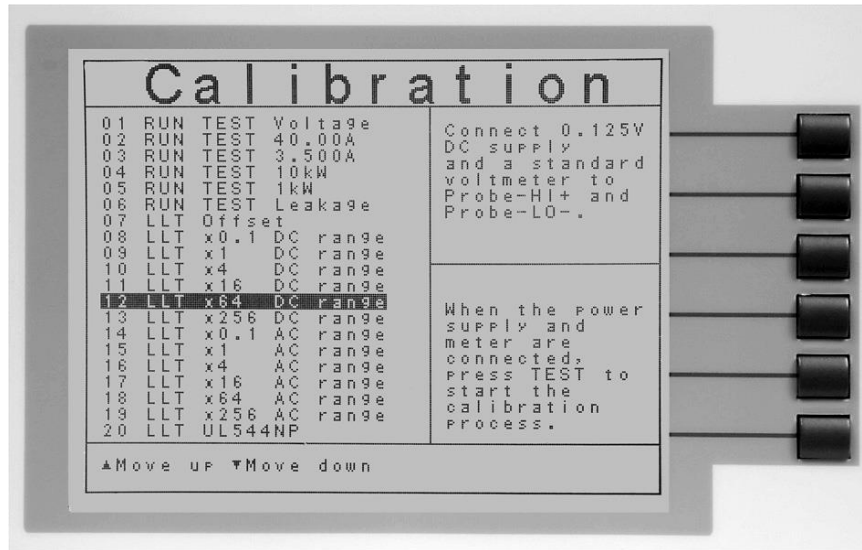

Upper Right Screen Load/Meter	Lower Right Screen Prompt	Lower Right Screen Prompt (Cal. Active)
Connect 0.125VDC and a voltmeter to Probe-HI + and Probe-LO -.	When the power supply and meter are connected, press TEST to start the calibration.	Enter Standard Voltage Reading.

Press the TEST button to activate the calibration. After the calibration is activated, the lower right screen will change to the text indicated in the table above (**Cal. Active**). Read the measurement from your standard and enter it using the numeric keypad. You may now store the new calibration number by pressing the ENTER key or escape by pressing the EXIT key or the RESET button.

### 9.2.13. Calibration of LLT MD Volts DC x 256

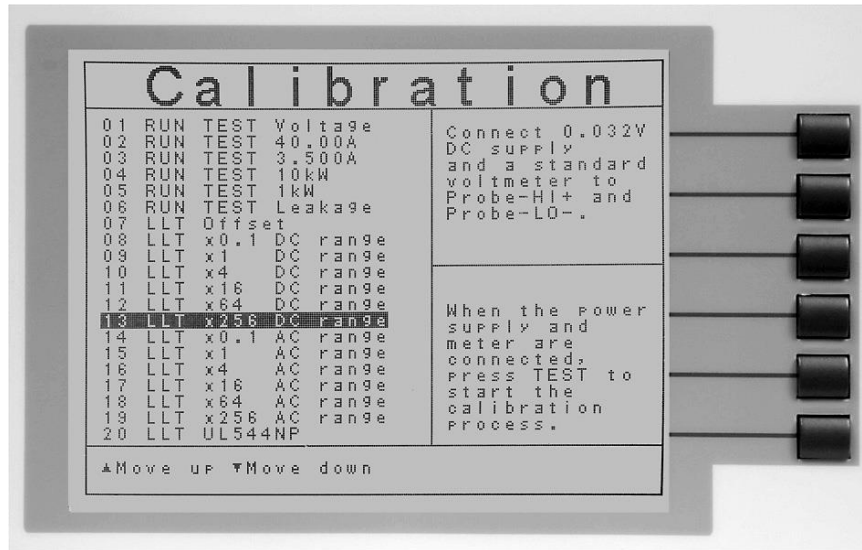

Upper Right Screen Load/Meter	Lower Right Screen Prompt	Lower Right Screen Prompt (Cal. Active)
Connect 0.032VDC and a voltmeter to Probe-HI + and Probe-LO -.	When the power supply and meter are connected, press TEST to start the calibration.	Enter Standard Voltage Reading.

Press the TEST button to activate the calibration. After the calibration is activated, the lower right screen will change to the text indicated in the table above (**Cal. Active**). Read the measurement from your standard and enter it using the numeric keypad. You may now store the new calibration number by pressing the ENTER key or escape by pressing the EXIT key or the RESET button.

### 9.2.14. Calibration of LLT MD Volts AC x 0.1

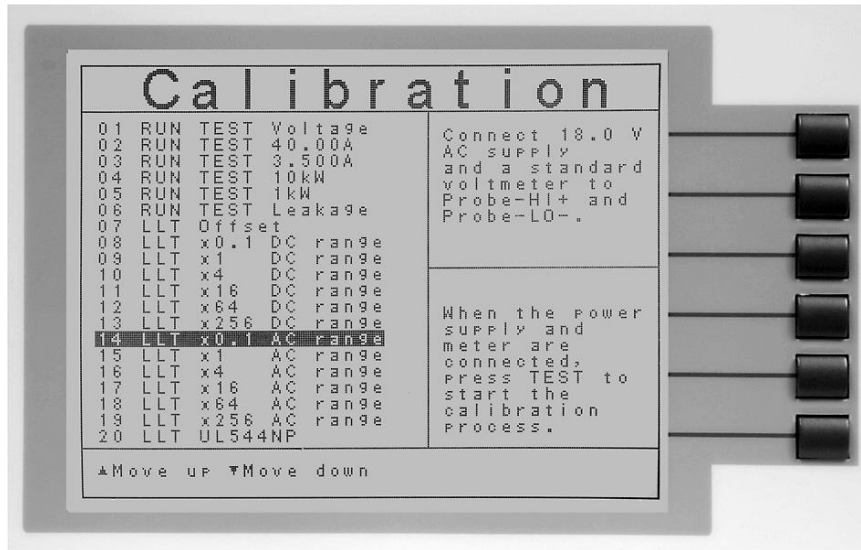

Upper Right Screen Load/Meter	Lower Right Screen Prompt	Lower Right Screen Prompt (Cal. Active)
Connect 18.0VAC supply and a voltmeter to Probe-HI + and Probe-LO -.	When the power supply and meter are connected, press TEST to start the calibration.	Enter Standard Voltage Reading.

Press the TEST button to activate the calibration. After the calibration is activated, the lower right screen will change to the text indicated in the table above (**Cal. Active**). Read the measurement from your standard and enter it using the numeric keypad. You may now store the new calibration number by pressing the ENTER key or escape by pressing the EXIT key or the RESET button.



### 9.2.15. Calibration of LLT MD Volts AC Peak x 0.1

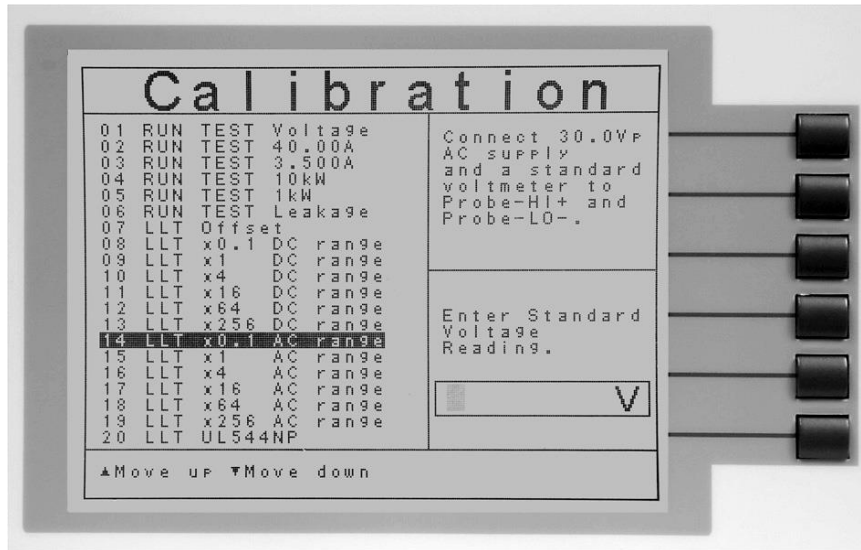

Upper Right Screen Load/Meter	Lower Right Screen Prompt	Lower Right Screen Prompt (Cal. Active)
Connect 30.0Vp AC supply and a voltmeter to Probe-HI + and Probe-LO -.	When the power supply and meter are connected, press TEST to start the calibration.	Enter Standard Voltage Reading.

After the RMS value has been input, the lower right screen will change to the text indicated in the table above (**Cal. Active**). Read the measurement from your standard and enter it using the numeric keypad. You may now store the new calibration number by pressing the ENTER key or escape by pressing the EXIT key or the RESET button.

### 9.2.16. Calibration of LLT MD Volts AC x 1

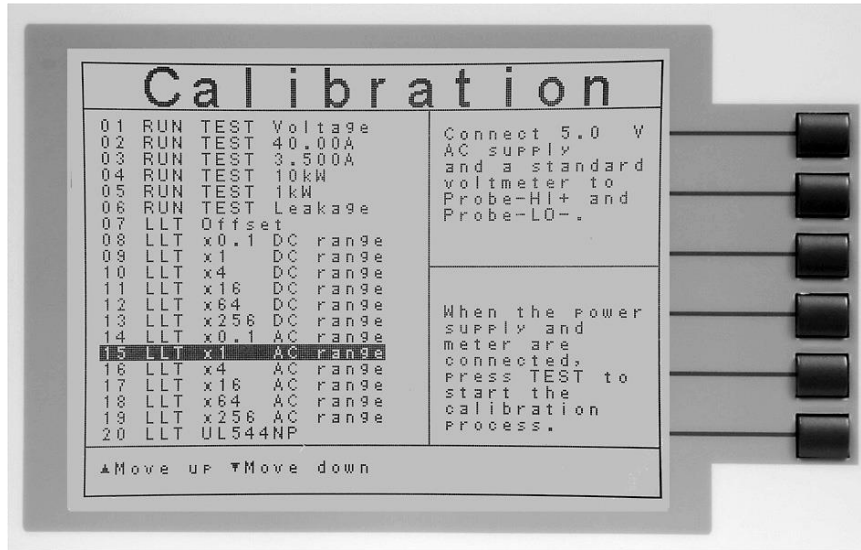

Upper Right Screen Load/Meter	Lower Right Screen Prompt	Lower Right Screen Prompt (Cal. Active)
Connect 5.0VAC supply and a voltmeter to Probe-HI + and Probe-LO -.	When the power supply and meter are connected, press TEST to start the calibration.	Enter Standard Voltage Reading.

Press the TEST button to activate the calibration. After the calibration is activated, the lower right screen will change to the text indicated in the table above (**Cal. Active**). Read the measurement from your standard and enter it using the numeric keypad. You may now store the new calibration number by pressing the ENTER key or escape by pressing the EXIT key or the RESET button.

### 9.2.17. Calibration of LLT MD Volts AC Peak x 1

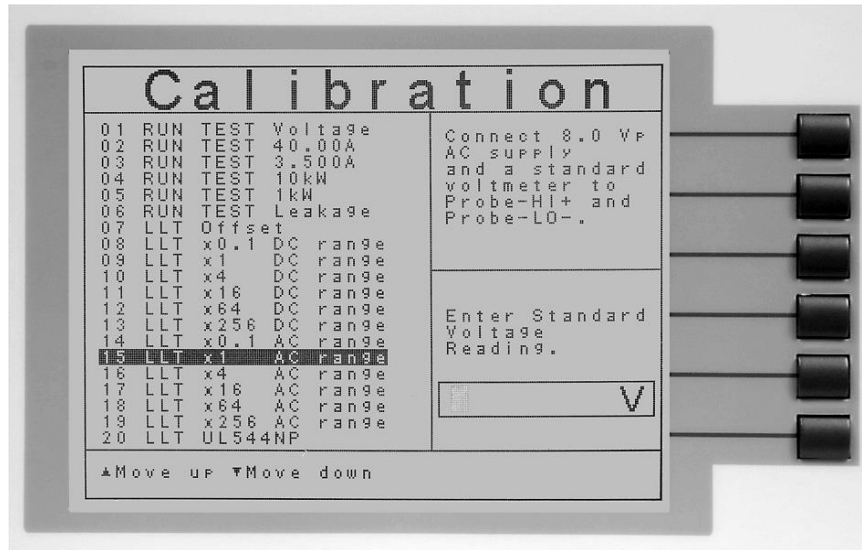

Upper Right Screen Load/Meter	Lower Right Screen Prompt	Lower Right Screen Prompt (Cal. Active)
Connect 8.0Vp AC supply and a voltmeter to Probe-HI + and Probe-LO -.	When the power supply and meter are connected, press TEST to start the calibration.	Enter Standard Voltage Reading.

After the RMS value has been input, the lower right screen will change to the text indicated in the table above (**Cal. Active**). Read the measurement from your standard and enter it using the numeric keypad. You may now store the new calibration number by pressing the ENTER key or escape by pressing the EXIT key or the RESET button.

### 9.2.18. Calibration of LLT MD Volts AC x 4

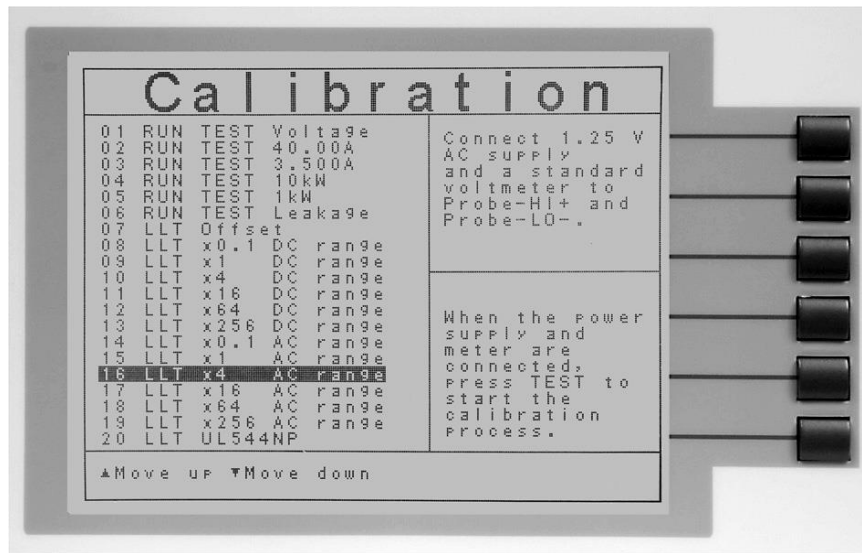

Upper Right Screen Load/Meter	Lower Right Screen Prompt	Lower Right Screen Prompt (Cal. Active)
Connect 1.25VAC supply and a voltmeter to Probe-HI + and Probe-LO -.	When the power supply and meter are connected, press TEST to start the calibration.	Enter Standard Voltage Reading.

Press the TEST button to activate the calibration. After the calibration is activated, the lower right screen will change to the text indicated in the table above (**Cal. Active**). Read the measurement from your standard and enter it using the numeric keypad. You may now store the new calibration number by pressing the ENTER key or escape by pressing the EXIT key or the RESET button.

### 9.2.19. Calibration of LLT MD Volts AC Peak x 4

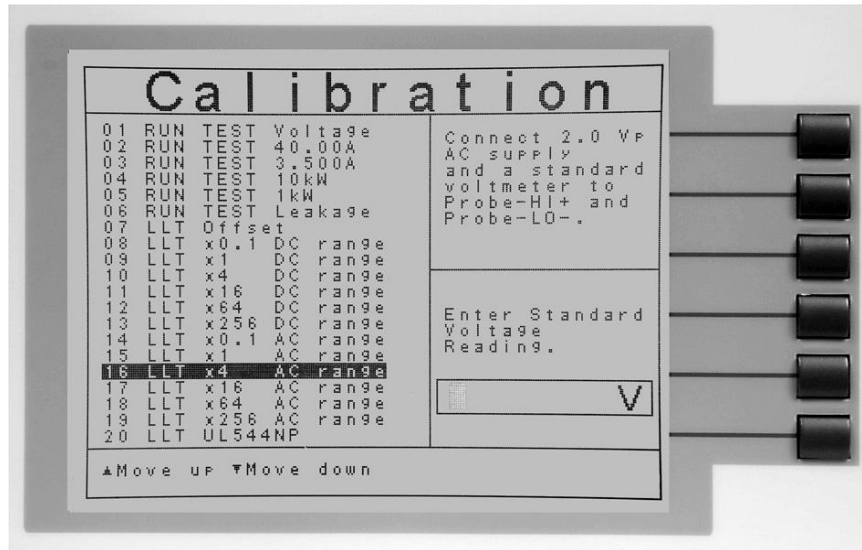

Upper Right Screen Load/Meter	Lower Right Screen Prompt	Lower Right Screen Prompt (Cal. Active)
Connect 2.0Vp AC supply and a voltmeter to Probe-HI + and Probe-LO -.	When the power supply and meter are connected, press TEST to start the calibration.	Enter Standard Voltage Reading.

After the RMS value has been input, the lower right screen will change to the text indicated in the table above (**Cal. Active**). Read the measurement from your standard and enter it using the numeric keypad. You may now store the new calibration number by pressing the ENTER key or escape by pressing the EXIT key or the RESET button.

### 9.2.20. Calibration of LLT MD Volts AC x 16

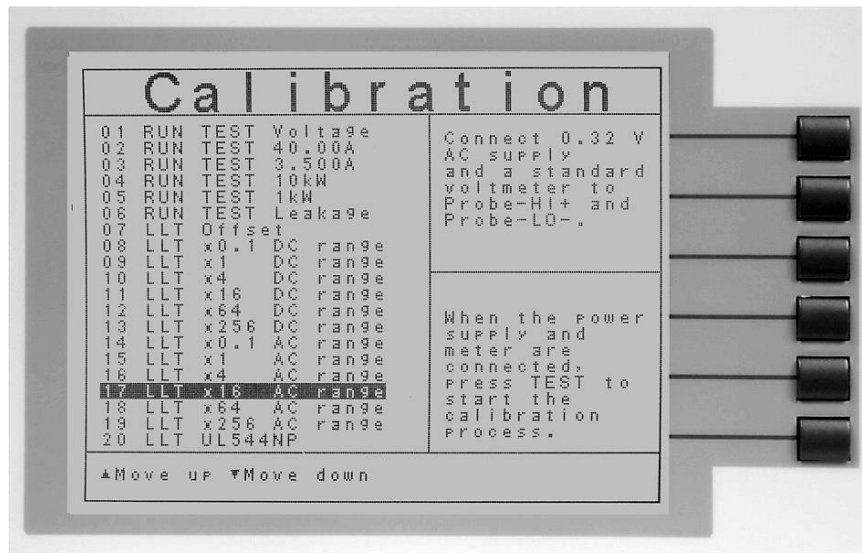

Upper Right Screen Load/Meter	Lower Right Screen Prompt	Lower Right Screen Prompt (Cal. Active)
Connect 0.32VAC supply and a voltmeter to Probe-HI + and Probe-LO -.	When the power supply and meter are connected, press TEST to start the calibration.	Enter Standard Voltage Reading.

Press the TEST button to activate the calibration. After the calibration is activated, the lower right screen will change to the text indicated in the table above (**Cal. Active**). Read the measurement from your standard and enter it using the numeric keypad. You may now store the new calibration number by pressing the ENTER key or escape by pressing the EXIT key or the RESET button.

### 9.2.21. Calibration of LLT MD Volts AC Peak x 16

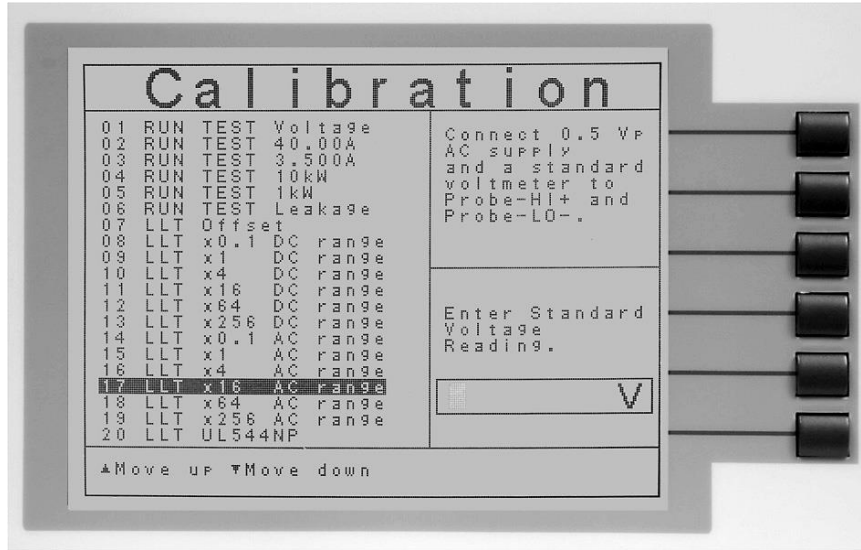

Upper Right Screen Load/Meter	Lower Right Screen Prompt	Lower Right Screen Prompt (Cal. Active)
Connect 0.5Vp AC supply and a voltmeter to Probe-HI + and Probe-LO - .	When the power supply and meter are connected, press TEST to start the calibration.	Enter Standard Voltage Reading.

After the RMS value has been input, the lower right screen will change to the text indicated in the table above (**Cal. Active**). Read the measurement from your standard and enter it using the numeric keypad. You may now store the new calibration number by pressing the ENTER key or escape by pressing the EXIT key or the RESET button.

### 9.2.22. Calibration of LLT MD Volts AC x 64

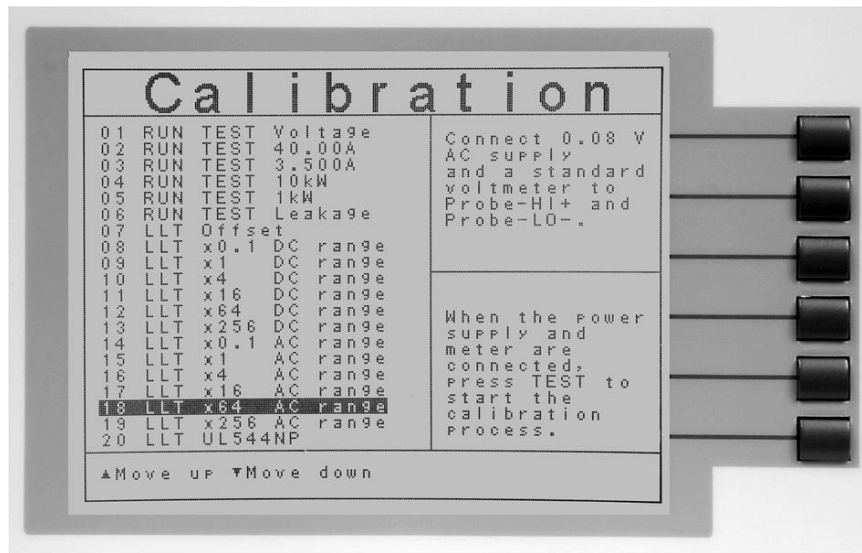

Upper Right Screen Load/Meter	Lower Right Screen Prompt	Lower Right Screen Prompt (Cal. Active)
Connect 0.08VAC supply and a voltmeter to Probe-HI + and Probe-LO -.	When the power supply and meter are connected, press TEST to start the calibration.	Enter Standard Voltage Reading.

Press the TEST button to activate the calibration. After the calibration is activated, the lower right screen will change to the text indicated in the table above (**Cal. Active**). Read the measurement from your standard and enter it using the numeric keypad. You may now store the new calibration number by pressing the ENTER key or escape by pressing the EXIT key or the RESET button.



### 9.2.23. Calibration of LLT MD Volts AC Peak x 64

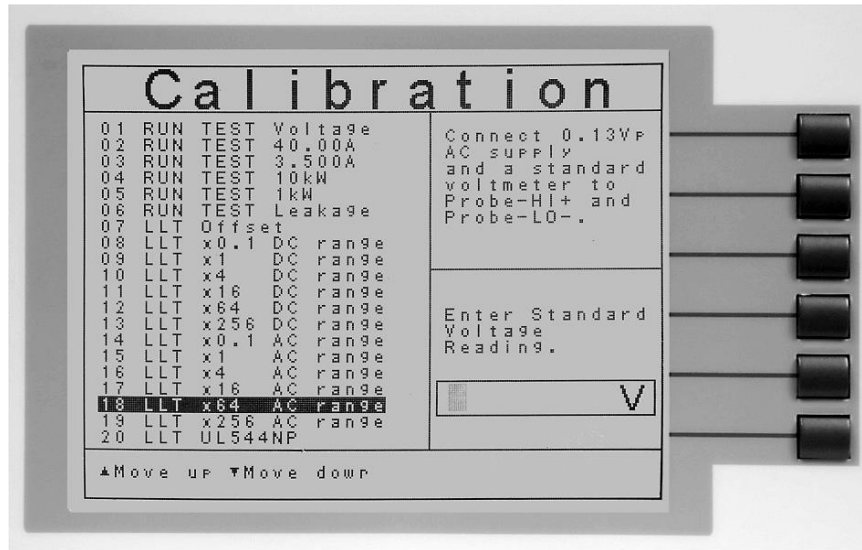

Upper Right Screen Load/Meter	Lower Right Screen Prompt	Lower Right Screen Prompt (Cal. Active)
Connect 0.13Vp AC supply and a voltmeter to Probe-HI + and Probe-LO -.	When the power supply and meter are connected, press TEST to start the calibration.	Enter Standard Voltage Reading.

After the RMS value has been input, the lower right screen will change to the text indicated in the table above (**Cal. Active**). Read the measurement from your standard and enter it using the numeric keypad. You may now store the new calibration number by pressing the ENTER key or escape by pressing the EXIT key or the RESET button.

### 9.2.24. Calibration of LLT MD Volts AC x 256

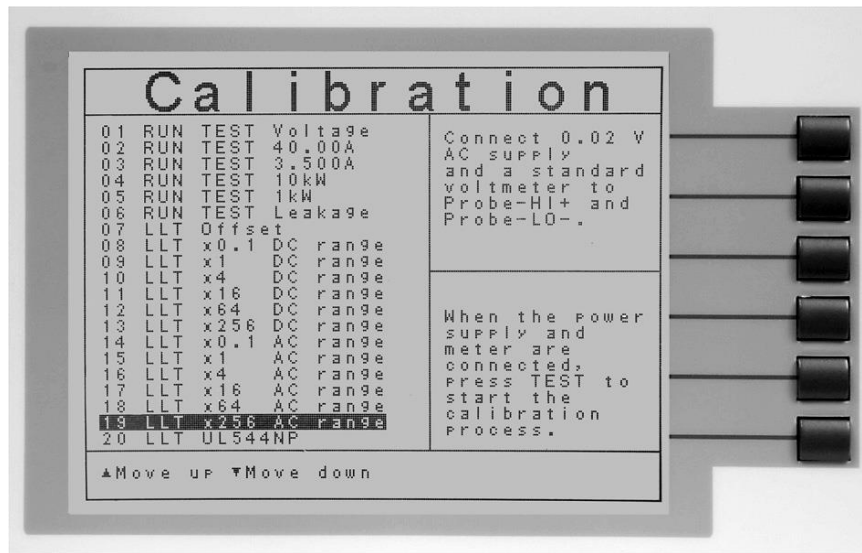

Upper Right Screen <b>Load/Meter</b>	Lower Right Screen <b>Prompt</b>	Lower Right Screen <b>Prompt (Cal. Active)</b>
Connect 0.02VAC supply and a voltmeter to Probe-HI + and Probe-LO -.	When the power supply and meter are connected, press TEST to start the calibration.	Enter Standard Voltage Reading.

Press the TEST button to activate the calibration. After the calibration is activated, the lower right screen will change to the text indicated in the table above (**Cal. Active**). Read the measurement from your standard and enter it using the numeric keypad. You may now store the new calibration number by pressing the ENTER key or escape by pressing the EXIT key or the RESET button.

### 9.2.25. Calibration of LLT MD Volts AC Peak x 256

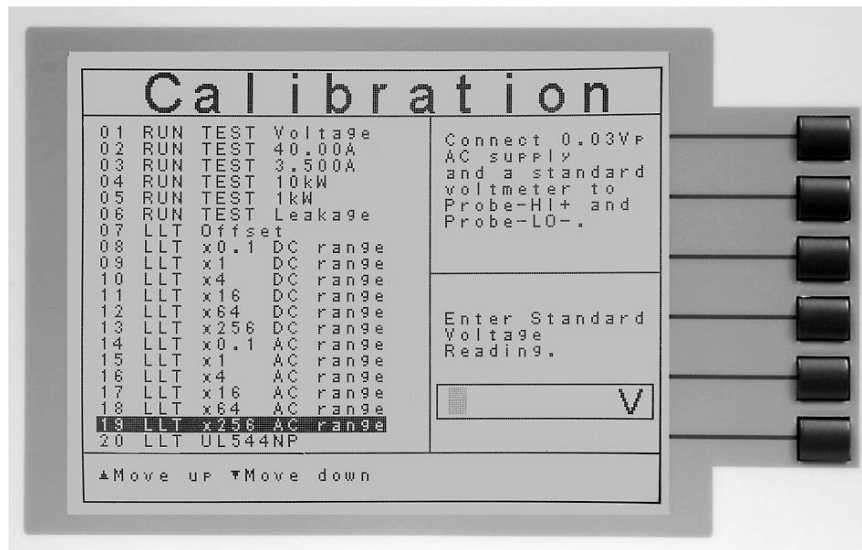

Upper Right Screen Load/Meter	Lower Right Screen Prompt	Lower Right Screen Prompt (Cal. Active)
Connect 0.03Vp AC supply and a voltmeter to Probe-HI + and Probe-LO -.	When the power supply and meter are connected, press TEST to start the calibration.	Enter Standard Voltage Reading.

After the RMS value has been input, the lower right screen will change to the text indicated in the table above (**Cal. Active**). Read the measurement from your standard and enter it using the numeric keypad. You may now store the new calibration number by pressing the ENTER key or escape by pressing the EXIT key or the RESET button.

### 9.2.26. Calibration of LLT MD: UL 544NP measuring device

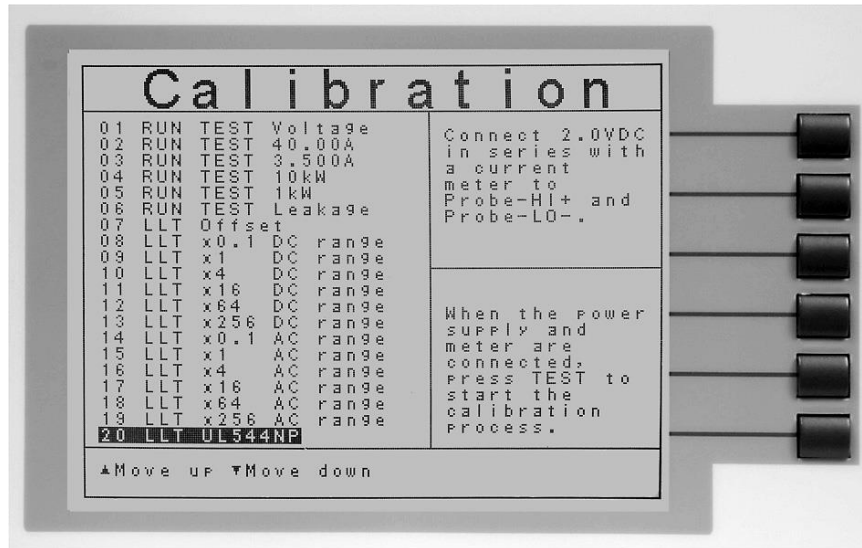

Upper Right Screen Load/Meter	Lower Right Screen Prompt	Lower Right Screen Prompt (Cal. Active)
Connect 2.0VDC in series with a current meter to Probe-HI + and Probe-LO -.	When the power supply and meter are connected, press TEST to start the calibration.	Enter Standard Current Reading.

Press the TEST button to activate the calibration. After the calibration is activated, the lower right screen will change to the text indicated in the table above (**Cal. Active**). You may now store the new calibration number by pressing the ENTER key or escape by pressing the EXIT key or the RESET button.

### 9.2.27. Calibration of LLT MD: UL 544P measuring device

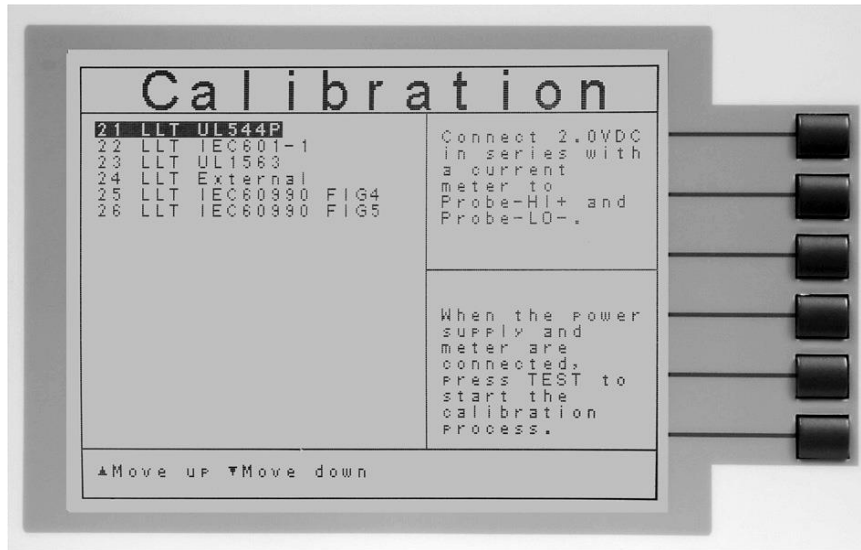

Upper Right Screen Load/Meter	Lower Right Screen Prompt	Lower Right Screen Prompt (Cal. Active)
Connect 2.0VDC in series with a current meter to Probe-HI + and Probe-LO -.	When the power supply and meter are connected, press TEST to start the calibration.	Enter Standard Current Reading.

Press the TEST button to activate the calibration. After the calibration is activated, the lower right screen will change to the text indicated in the table above (**Cal. Active**). Read the measurement from your standard and enter it using the numeric keypad. You may now store the new calibration number by pressing the ENTER key or escape by pressing the EXIT key or the RESET button.

### 9.2.28. Calibration of LLT MD: ICE601-1 measuring device

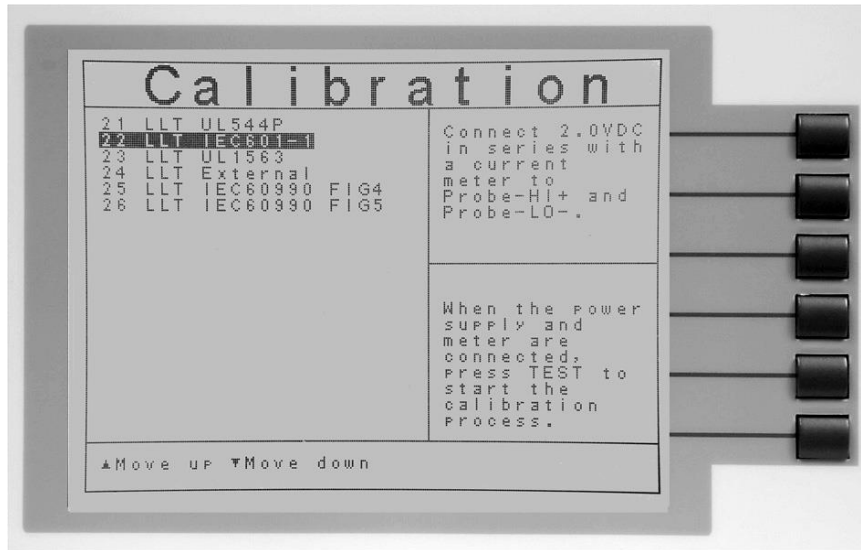

Upper Right Screen Load/Meter	Lower Right Screen Prompt	Lower Right Screen Prompt (Cal. Active)
Connect 2.0VDC in series with a current meter to Probe-HI + and Probe-LO -.	When the power supply and meter are connected, press TEST to start the calibration.	Enter Standard Current Reading.

Press the TEST button to activate the calibration. After the calibration is activated, the lower right screen will change to the text indicated in the table above (**Cal. Active**). Read the measurement from your standard and enter it using the numeric keypad. You may now store the new calibration number by pressing the ENTER key or escape by pressing the EXIT key or the RESET button.

### 9.2.29. Calibration of LLT MD: UL1563 measuring device

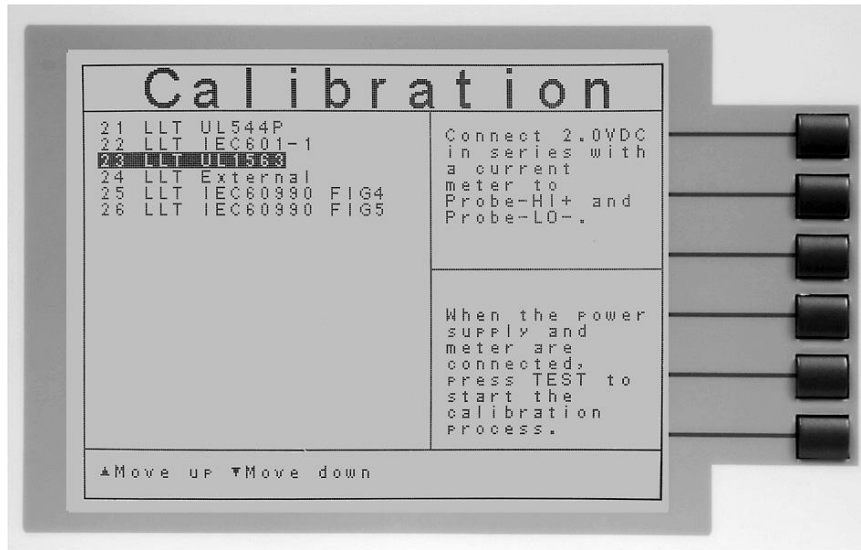

Upper Right Screen Load/Meter	Lower Right Screen Prompt	Lower Right Screen Prompt (Cal. Active)
Connect 2.0VDC in series with a current meter to Probe-HI + and Probe-LO -.	When the power supply and meter are connected, press TEST to start the calibration.	Enter Standard Current Reading.

Press the TEST button to activate the calibration. After the calibration is activated, the lower right screen will change to the text indicated in the table above (**Cal. Active**). Read the measurement from your standard and enter it using the numeric keypad. You may now store the new calibration number by pressing the ENTER key or escape by pressing the EXIT key or the RESET button.

### 9.2.30. Calibration of LLT MD: External

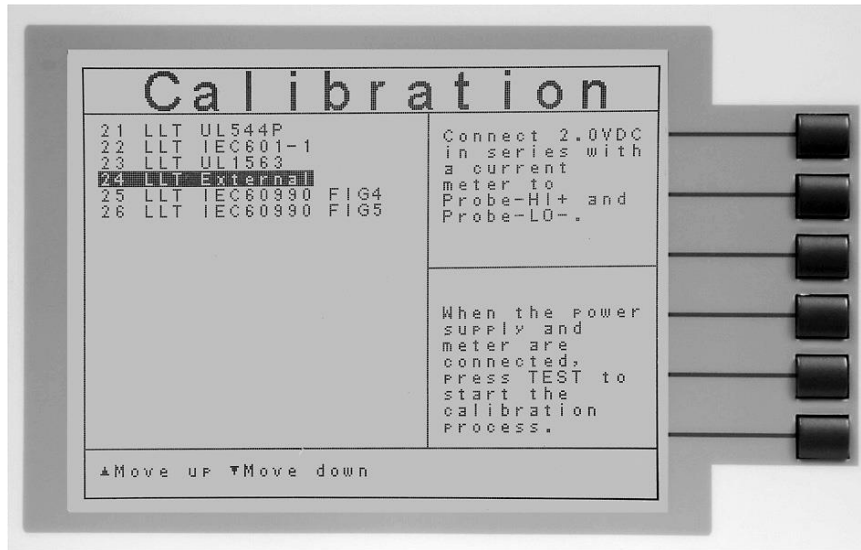

Upper Right Screen Load/Meter	Lower Right Screen Prompt	Lower Right Screen Prompt (Cal. Active)
Connect 2.0VDC in series with a current meter to Probe-HI + and Probe-LO -.	When the power supply and meter are connected, press TEST to start the calibration.	Enter Standard Current Reading.

Press the TEST button to activate the calibration. After the calibration is activated, the lower right screen will change to the text indicated in the table above (**Cal. Active**). Read the measurement from your standard and enter it using the numeric keypad. You may now store the new calibration number by pressing the ENTER key or escape by pressing the EXIT key or the RESET button.



### 9.2.31. Calibration of LLT MD: IEC60990 FIG4

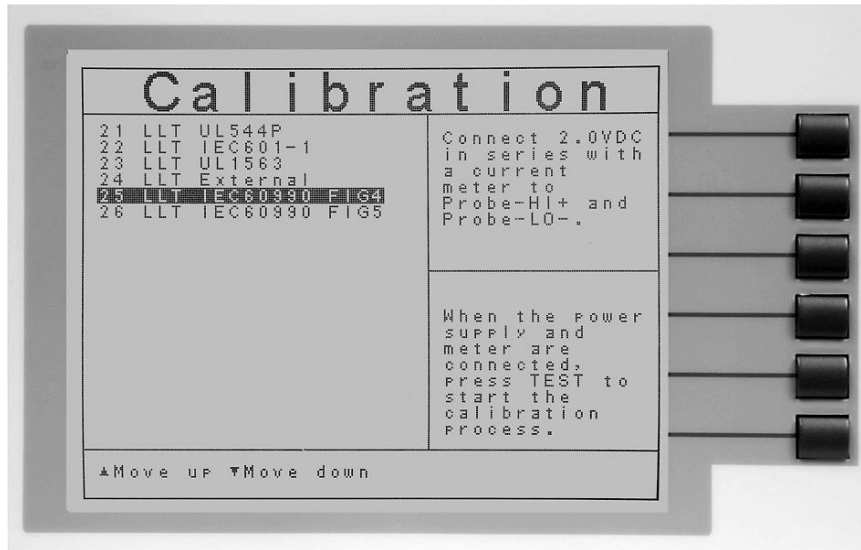

Upper Right Screen Load/Meter	Lower Right Screen Prompt	Lower Right Screen Prompt (Cal. Active)
Connect 2.0VDC in series with a current meter to Probe-HI + and Probe-LO -.	When the power supply and meter are connected, press TEST to start the calibration.	Enter Standard Current Reading.

Press the TEST button to activate the calibration. After the calibration is activated, the lower right screen will change to the text indicated in the table above (**Cal. Active**). Read the measurement from your standard and enter it using the numeric keypad. You may now store the new calibration number by pressing the ENTER key or escape by pressing the EXIT key or the RESET button.

**9.2.32. Calibration of LLT MD: IEC60990 FIG5**

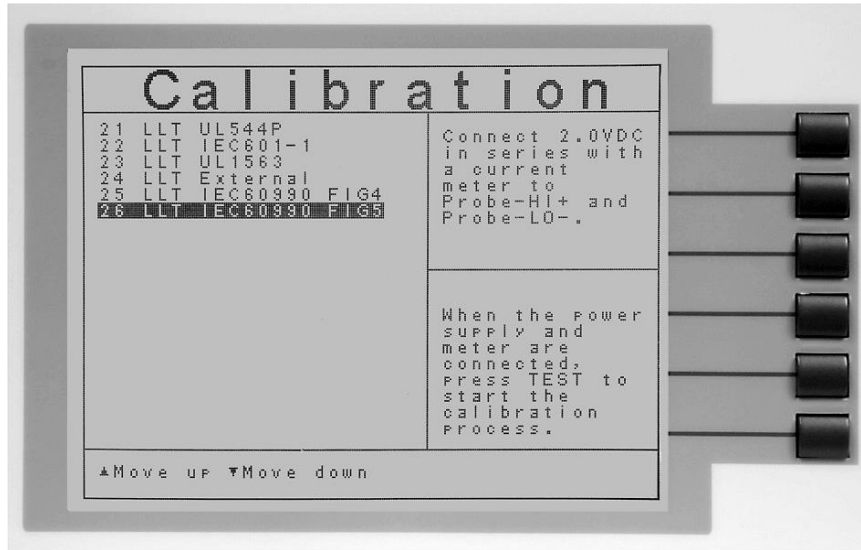

Upper Right Screen Load/Meter	Lower Right Screen Prompt	Lower Right Screen Prompt (Cal. Active)
Connect 2.0VDC in series with a current meter to Probe-HI + and Probe-LO -.	When the power supply and meter are connected, press TEST to start the calibration.	Enter Standard Current Reading.

Press the TEST button to activate the calibration. After the calibration is activated, the lower right screen will change to the text indicated in the table above (**Cal. Active**). Read the measurement from your standard and enter it using the numeric keypad. You may now store the new calibration number by pressing the ENTER key or escape by pressing the EXIT key or the RESET button.

## 10. REPLACEMENT PARTS

Rev. D 4/9/14 ECO 5673-3

PART NUMBER	QTY	REF. DESIGNATOR	DESCRIPTION
<b>Supplied Accessories</b>			
38787	2	-	3U Rack Mount Handle
38788	2	-	3U Rack Mount Bracket
38549	4	-	Screw for Rack Mount Handle
37923	1	-	Fuse 2A 250V Slow Blow 20mm
02100A-13	2	-	Cable Assembly Probe
38841	1	-	Cable Assembly Input LINE
38842	1	-	Cable Assembly Input NEUTRAL
38833	1	-	Cable Assembly Output LINE
38834	1	-	Cable Assembly Output NEUTRAL
39066	1	-	USB Cable AB-Type 1.8m
33189	1	-	Cable Input Cordset USA
38075	1	-	Interlock Connector
38777	1	-	Adapter Box
CBLHC40-10TLR	1	-	Cable Assembly High Current Lead Red
<b>Panel Components</b>			
38364	1	-	Fuse Holder 20mm
35999	2	-	Probe HI and Probe LO Jack
38446	1	-	GND Terminal Red
38069	1	-	Power Switch
37571	1	-	Earth Connector
37806	1	TEST	Test Switch Green Lighted
37807	1	RESET	Reset Switch Red Lighted
39391	1	TEST	Replacement Bulb
39392	1	RESET	Replacement Bulb
38101	1	-	Feet Kit w/o Rubber Inserts
38102	4	-	Rubber Insert for Feet
38225	1	-	Graphic LCD Display
<b>PCB Assemblies</b>			
38824	1	CON7630	Main Control Board
39099	1	ANG7630	Analog Board
39367	1	LAM7630	AC/DC Filter Board
38826	1	PM7630	Power Meter Board
38827	1	MD7630	Measuring Device Board
38838	1	MD7500	External Measuring Device Board
38828	1	SW7630	DUT Power Switch Board
38830	1	KEY7630	Keypad Board
38268	1	PWR3670	Input Protection Board

<b>PART NUMBER</b>	<b>QTY</b>	<b>REF. DESIGNATOR</b>	<b>DESCRIPTION</b>
39063	1	USB/RS232	USB/RS232 Interface Board
38305	1	CGP-03	GPIB Interface Board
38801	1	USB	Data Storage Card (DISCONTINUED)
38819	1	38818	Ethernet Card
<b>Internal Components</b>			
38845	1	T1	Input Transformer
38847	1	T2	Isolation Transformer
39114	1	IC 37	IC 39SF020A EEPROM PLCC
39350	1	IC 42	IC SM59128 Microcontroller PLCC
Part Number	Qty.	Ref. Designator	Description
<b>Hipot/Ground Bond Interconnect option</b>			
38829	1	SW7630	DUT Power Switch Board
04040A-08	2	-	Cable Assembly Probe-HV
38835	1	-	Cable Assembly Output LINE-HV
38836	1	-	Cable Assembly Output NEUTRAL-HV
CBLHC40-10TL	1	-	Cable Assembly High Current Lead Black

## 11. APPENDIX A

These are additional specifications for the 620L for the AC and DC filtering.

<b>LEAKAGE LIMIT SETTING</b>		
Touch Current High Limit (AC+DC)	Range:	0.0uA ~ 999.9uA 1000uA ~ 9999uA 10.00mA ~ 20.00mA
	Resolution:	0.1uA / 1uA / 0.01mA
Touch Current Low Limit (AC+DC)	Range:	0.0uA ~ 999.9uA 1000uA ~ 9999uA 10.00mA ~ 20.00mA
	Resolution:	0.1uA/1uA/0.01mA
Touch Current High Limit (AC Only)	Range:	0.0uA ~ 999.9uA 1000uA ~ 9999uA 10.00mA ~ 20.00mA
	Resolution:	0.1uA / 1uA / 0.01mA
Touch Current Low Limit (AC Only)	Range:	0.0uA ~ 999.9uA 1000uA ~ 9999uA 10.00mA ~ 20.00mA
	Resolution:	0.1uA/1uA/0.01mA
Touch Current High Limit (DC Only)	Range:	0.0uA ~ 999.9uA 1000uA ~ 9999uA 10.00mA ~ 20.00mA
	Resolution:	0.1uA / 1uA / 0.01mA
Touch Current Low Limit (DC Only)	Range:	0.0uA ~ 999.9uA 1000uA ~ 9999uA 10.00mA ~ 20.00mA
	Resolution:	0.1uA/1uA/0.01mA
Touch Current High Limit (Peak)	Range:	0.0uA - 999.9uA 1000uA - 9999uA 10.00mA - 30.00mA
	Resolution:	0.1uA/1uA/0.01mA
Touch Current Low Limit (Peak)	Range:	0.0uA - 999.9uA 1000uA - 9999uA 10.00mA - 30.00mA
	Resolution:	0.1uA/1uA/0.01mA

<b>DISPLAY AUTO RANGE</b>		
Touch Current Display (RMS) (AC+DC)	Range 1	0.0uA ~ 32.0uA, frequency DC, 15Hz – 1MHz
	Resolution	0.1uA
	Accuracy	DC , 15Hz ≤ f <100KHz: ±(2% of reading + 3counts) 100KHz ≤ f ≤ 1MHZ : ±5% of reading (10.0uA - 999.9uA)
	Range 2	28.0uA ~ 130.0uA, frequency DC, 15Hz - 1MHz
	Resolution	0.1uA
	Accuracy	DC , 15Hz ≤ f <100KHz: ±(2% of reading + 3counts) 100KHz ≤ f ≤ 1MHZ : ±5% of reading (10.0uA - 999.9uA)
	Range 3	120.0uA ~ 525.0uA, frequency DC, 15Hz - 1MHz
	Resolution	0.1uA
	Accuracy	DC , 15Hz ≤ f <100KHz: ±(2% of reading + 3counts) 100KHz ≤ f ≤ 1MHZ : ±5% of reading (10.0uA - 999.9uA)
	Range 4	400uA ~ 2100uA, frequency DC, 15Hz - 1MHz
	Resolution	1uA
	Accuracy	DC , 15Hz ≤ f <100KHz: ±(2% of reading + 3counts) 100KHz ≤ f ≤ 1MHZ : ±5% of reading (10uA - 8500uA)
	Range 5	1800uA ~ 8400uA, frequency DC, 15Hz - 1MHz
	Resolution	1uA
	Accuracy	DC , 15Hz ≤ f <100KHz: ±(2% of reading + 3counts) 100KHz ≤ f ≤ 1MHZ : ±5% of reading (10uA - 8500uA)
	Range 6	8.00mA ~ 20.00mA, frequency DC, 15Hz – 100kHz

	Resolution	0.01mA
	Accuracy	DC, $15\text{Hz} \leq f \leq 100\text{KHz}$ : $\pm 5\%$ of reading (0.01mA -20.00mA )
<b>DISPLAY FIXED RANGE (&gt;6% OF RANGE)</b>		
Touch Current Display (RMS) (AC+DC)	Range 1	0.0uA ~ 32.0uA, frequency DC - 1MHz
	Resolution	0.1uA
	Base Accuracy	DC, $15\text{Hz} \leq f \leq 100\text{KHz}$ : $\pm(2\%$ of reading + 3counts) $100\text{KHz} \leq f \leq 1\text{MHz}$ : $\pm 5\%$ of reading (10.0uA - 999.9uA)
	Range 2	7.8uA ~ 130.0uA, frequency DC - 1MHz
	Resolution	0.1uA
	Base Accuracy	DC, $15\text{Hz} \leq f \leq 100\text{KHz}$ : $\pm(2\%$ of reading + 3counts) $100\text{KHz} \leq f \leq 1\text{MHz}$ : $\pm 5\%$ of reading (10.0uA - 999.9uA)
	Range 3	31.5uA ~ 525.0uA, frequency DC - 1MHz
	Resolution	0.1uA
	Base Accuracy	DC, $15\text{Hz} \leq f \leq 100\text{KHz}$ : $\pm(2\%$ of reading + 3counts) $100\text{KHz} \leq f \leq 1\text{MHz}$ : $\pm 5\%$ of reading (10.0uA - 999.9uA)
	Range 4	126.0uA ~ 999.9uA, 1000uA ~ 2100uA, frequency DC - 1MHz
	Resolution	0.1uA, 1uA
	Base Accuracy	DC, $15\text{Hz} \leq f \leq 100\text{KHz}$ : $\pm(2\%$ of reading + 3counts) $100\text{KHz} \leq f \leq 1\text{MHz}$ : $\pm 5\%$ of reading (10.0uA - 999.9uA)
	Range 5	504uA ~ 999.9uA, 1000uA ~ 8400uA, frequency DC - 1MHz
	Resolution	0.1uA, 1uA
	Base Accuracy	DC, $15\text{Hz} \leq f \leq 100\text{KHz}$ : $\pm(2\%$ of reading + 3counts) $100\text{KHz} \leq f \leq 1\text{MHz}$ : $\pm 5\%$ of reading (10.0uA - 999.9uA)
	Range 6	1200uA ~ 8399uA, 8.40mA ~ 20.00mA, frequency DC – 100KHz

	Resolution	1uA, 0.01mA
	Base Accuracy	DC, $15\text{Hz} \leq f \leq 100\text{KHz}$ : $\pm 5\%$ of reading (0.01mA -20.00mA )
<b>DISPLAY FIXED RANGE (&lt;6% OF RANGE)</b>		
Touch Current Display (RMS) (AC+DC)	Range 1	N/A
	Resolution	N/A
	Additional Error	N/A
	Range 2	0.0uA ~ 7.8uA, frequency DC - 1MHz
	Resolution	0.1uA
	Additional Error	DC, $15\text{Hz} \leq f \leq 100\text{KHz}$ : add $\pm(2\%$ of reading + 0.2% of range) to base accuracy $100\text{KHz} \leq f \leq 1\text{MHz}$ : add $\pm(2\%$ of reading + 0.5% of range) to base accuracy
	Range 3	0.0uA ~ 31.5uA, frequency DC - 1MHz
	Resolution	0.1uA
	Additional Error	DC, $15\text{Hz} \leq f \leq 100\text{KHz}$ : add $\pm(2\%$ of reading + 0.2% of range) to base accuracy $100\text{KHz} \leq f \leq 1\text{MHz}$ : add $\pm(2\%$ of reading + 0.5% of range) to base accuracy
	Range 4	0.0uA ~ 126.0uA, frequency DC - 1MHz
	Resolution	0.1uA
	Additional Error	DC, $15\text{Hz} \leq f \leq 100\text{KHz}$ : add $\pm(2\%$ of reading + 0.2% of range) to base accuracy $100\text{KHz} \leq f \leq 1\text{MHz}$ : add $\pm(2\%$ of reading + 0.5% of range) to base accuracy
	Range 5	0.0uA ~ 504uA, frequency DC - 1MHz
	Resolution	0.1uA



	Additional Error	DC, $15\text{Hz} \leq f \leq 100\text{KHz}$ : add $\pm(2\%$ of reading + 0.2% of range) to base accuracy $100\text{KHz} \leq f \leq 1\text{MHz}$ : add $\pm(2\%$ of reading + 0.5% of range) to base accuracy
	Range 6	0.0uA ~ 999.9uA, 1000uA ~ 1200uA, frequency DC – 100KHz
	Resolution	0.1uA, 1uA
	Additional Error	DC, $15\text{Hz} \leq f \leq 100\text{KHz}$ : add $\pm(2\%$ of reading + 0.2% of range) to base accuracy

### DISPLAY AUTO RANGE

Touch Current Display (RMS) (AC Only)	Range 1	0.0uA ~ 32.0uA, frequency 15Hz – 1MHz
	Resolution	0.1uA
	Accuracy	$15\text{Hz} \leq f < 30\text{Hz}$ : $\pm(3\%$ of reading + 5counts) $30\text{Hz} \leq f \leq 100\text{KHz}$ : $\pm(2\%$ of reading + 3counts) $100\text{KHz} \leq f \leq 1\text{MHz}$ : $\pm 5\%$ of reading (10.0uA - 999.9uA)
	Range 2	28.0uA ~ 130.0uA, frequency 15Hz - 1MHz
	Resolution	0.1uA
	Accuracy	$15\text{Hz} \leq f < 30\text{Hz}$ : $\pm(3\%$ of reading + 5counts) $30\text{Hz} \leq f \leq 100\text{KHz}$ : $\pm(2\%$ of reading + 3counts) $100\text{KHz} \leq f \leq 1\text{MHz}$ : $\pm 5\%$ of reading (10.0uA - 999.9uA)
	Range 3	120.0uA ~ 525.0uA, frequency 15Hz - 1MHz
	Resolution	0.1uA
	Accuracy	$15\text{Hz} \leq f < 30\text{Hz}$ : $\pm(3\%$ of reading + 5counts) $30\text{Hz} \leq f \leq 100\text{KHz}$ : $\pm(2\%$ of reading + 3counts) $100\text{KHz} \leq f \leq 1\text{MHz}$ : $\pm 5\%$ of reading (10.0uA - 999.9uA)
	Range 4	400uA ~ 2100uA, frequency 15Hz - 1MHz
	Resolution	1uA

	Accuracy	15Hz ≤ f < 30Hz: ±(3% of reading + 5counts) 30Hz ≤ f ≤ 100KHz : ±(2% of reading + 3counts) 100KHz ≤ f ≤ 1MHZ : ±5% of reading (10.0uA - 999.9uA)
	Range 5	1800uA ~ 8400uA, frequency 15Hz - 1MHz
	Resolution	1uA
	Accuracy	15Hz ≤ f < 30Hz: ±(3% of reading + 5counts) 30Hz ≤ f ≤ 100KHz : ±(2% of reading + 3counts) 100KHz ≤ f ≤ 1MHZ : ±5% of reading (10.0uA - 999.9uA)
	Range 6	8.00mA ~ 20.00mA, frequency 15Hz – 100kHz
	Resolution	0.01mA
	Accuracy	15Hz < f < 100KHz : ±5% of reading (0.01mA -20.00mA )
<b>DISPLAY FIXED RANGE (&gt;6% OF RANGE)</b>		
Touch Current Display (RMS) (AC Only)	Range 1	0.0uA ~ 32.0uA, frequency 15Hz - 1MHz
	Resolution	0.1uA
	Base Accuracy	15Hz ≤ f < 30Hz: ±(3% of reading + 5counts) 30Hz ≤ f ≤ 100KHz : ±(2% of reading + 3counts) 100KHz ≤ f ≤ 1MHZ : ±5% of reading (10.0uA - 999.9uA)
	Range 2	7.8uA ~ 130.0uA, frequency 15Hz - 1MHz
	Resolution	0.1uA
	Base Accuracy	15Hz ≤ f < 30Hz: ±(3% of reading + 5counts) 30Hz ≤ f ≤ 100KHz : ±(2% of reading + 3counts) 100KHz ≤ f ≤ 1MHZ : ±5% of reading (10.0uA - 999.9uA)
	Range 3	31.5uA ~ 525.0uA, frequency 15Hz - 1MHz
	Resolution	0.1uA

	Base Accuracy	15Hz ≤ f < 30Hz: ±(3% of reading + 5counts) 30Hz ≤ f ≤ 100KHz : ±(2% of reading + 3counts) 100KHz ≤ f ≤ 1MHz : ±5% of reading (10.0uA - 999.9uA)
	Range 4	126.0uA ~ 999.9uA, 1000uA ~ 2100uA, frequency 15Hz - 1MHz
	Resolution	0.1uA, 1uA
	Base Accuracy	15Hz ≤ f < 30Hz: ±(3% of reading + 5counts) 30Hz ≤ f ≤ 100KHz : ±(2% of reading + 3counts) 100KHz ≤ f ≤ 1MHz : ±5% of reading (10.0uA - 999.9uA)
	Range 5	504uA ~ 999.9uA, 1000uA ~ 8400uA, frequency 15Hz - 1MHz
	Resolution	0.1uA, 1uA
	Base Accuracy	15Hz ≤ f < 30Hz: ±(3% of reading + 5counts) 30Hz ≤ f ≤ 100KHz : ±(2% of reading + 3counts) 100KHz ≤ f ≤ 1MHz : ±5% of reading (10.0uA - 999.9uA)
	Range 6	1200uA ~ 8399uA, 8.40mA ~ 20.00mA, frequency 15Hz - 1MHz
	Resolution	1uA, 0.01mA
	Base Accuracy	15Hz ≤ f ≤ 100KHz : ±5% of reading (0.01mA - 20.00mA )
<b>DISPLAY FIXED RANGE (&lt;6% OF RANGE)</b>		
Touch Current Display (RMS) (AC Only)	Range 1	N/A
	Resolution	N/A
	Additional Error	N/A
	Range 2	0.0uA ~ 7.8uA, frequency 15Hz - 1MHz
	Resolution	0.1uA

	Additional Error	$15\text{Hz} \leq f < 30\text{Hz}$ : add $\pm(2\%$ of reading + 0.2% of range) to base accuracy $30\text{Hz} \leq f \leq 100\text{KHz}$ : add $\pm(2\%$ of reading + 0.2% of range) to base accuracy $100\text{KHz} \leq f \leq 1\text{MHz}$ : add $\pm(2\%$ of reading + 0.5% of range) to base accuracy
	Range 3	0.0uA ~ 31.5uA, frequency 15Hz - 1MHz
	Resolution	0.1uA
	Additional Error	$15\text{Hz} \leq f < 30\text{Hz}$ : add $\pm(2\%$ of reading + 0.2% of range) to base accuracy $30\text{Hz} \leq f \leq 100\text{KHz}$ : add $\pm(2\%$ of reading + 0.2% of range) to base accuracy $100\text{KHz} \leq f \leq 1\text{MHz}$ : add $\pm(2\%$ of reading + 0.5% of range) to base accuracy
	Range 4	0.0uA ~ 126.0uA, frequency 15Hz - 1MHz
	Resolution	0.1uA
	Additional Error	$15\text{Hz} \leq f < 30\text{Hz}$ : add $\pm(2\%$ of reading + 0.2% of range) to base accuracy $30\text{Hz} \leq f \leq 100\text{KHz}$ : add $\pm(2\%$ of reading + 0.2% of range) to base accuracy $100\text{KHz} \leq f \leq 1\text{MHz}$ : add $\pm(2\%$ of reading + 0.5% of range) to base accuracy
	Range 5	0.0uA ~ 504uA, frequency 15Hz - 1MHz
	Resolution	0.1uA

	Additional Error	$15\text{Hz} \leq f < 30\text{Hz}$ : add $\pm(2\%$ of reading + 0.2% of range) to base accuracy $30\text{Hz} \leq f \leq 100\text{KHz}$ : add $\pm(2\%$ of reading + 0.2% of range) to base accuracy $100\text{KHz} \leq f \leq 1\text{MHz}$ : add $\pm(2\%$ of reading + 0.5% of range) to base accuracy
	Range 6	0.0uA ~ 999.9uA, 1000uA ~ 1200uA, frequency DC – 100KHz
	Resolution	0.1uA, 1uA
	Additional Error	$15\text{Hz} \leq f \leq 100\text{KHz}$ : add $\pm(2\%$ of reading + 0.2% of range) to base accuracy
<b>DISPLAY AUTO RANGE</b>		
Touch Current Display (DC Only)	Range 1	0.0uA ~ 32.0uA, DC
	Resolution	0.1uA
	Accuracy	DC : $\pm(2\%$ of reading + 3counts)
	Range 2	28.0uA ~ 130.0uA, DC
	Resolution	0.1uA
	Accuracy	DC : $\pm(2\%$ of reading + 3counts)
	Range 3	120.0uA ~ 525.0uA, DC
	Resolution	0.1uA
	Accuracy	DC : $\pm(2\%$ of reading + 3counts)
	Range 4	400uA ~ 2100uA, DC
	Resolution	1uA
	Accuracy	DC : $\pm(2\%$ of reading + 3counts)
	Range 5	1800uA ~ 8400uA, DC
	Resolution	1uA
	Accuracy	DC : $\pm(2\%$ of reading + 3counts)
Range 6	8.00mA ~ 20.00mA, DC	
Resolution	0.01mA	

	Accuracy	DC : $\pm 5\%$ of reading (0.01mA - 20.00mA )	
<b>DISPLAY FIXED RANGE (&gt;6% OF RANGE)</b>			
Touch Current Display (DC Only)	Range 1	0.0uA ~ 32.0uA, DC	
	Resolution	0.1uA	
	Base Accuracy	DC : $\pm(2\%$ of reading + 3counts) (>10uA)	
	Range 2	7.8uA ~ 130.0uA, DC	
	Resolution	0.1uA	
	Base Accuracy	DC : $\pm(2\%$ of reading + 3counts) (>10uA)	
	Range 3	31.5uA ~ 525.0uA, DC	
	Resolution	0.1uA	
	Base Accuracy	DC : $\pm(2\%$ of reading + 3counts) (>10uA)	
	Range 4	126.0uA ~ 999.9uA, 1000uA ~ 2100uA, DC	
	Resolution	0.1uA, 1uA	
	Base Accuracy	DC : $\pm(2\%$ of reading + 3counts) (>10uA)	
	Range 5	504uA ~ 999.9uA, 1000uA ~ 8400uA, DC	
	Resolution	0.1uA, 1uA	
	Base Accuracy	DC : $\pm(2\%$ of reading + 3counts) (>10uA)	
	Range 6	1200uA ~ 8399uA, 8.40mA ~ 20.00mA, DC	
	Resolution	1uA, 0.01mA	
	Base Accuracy	DC : $\pm 5\%$ of reading (0.01mA - 20.00mA )	
	<b>DISPLAY FIXED RANGE (&lt;6% OF RANGE)</b>		
	Touch Current Display (DC Only)	Range 1	N/A
		Resolution	N/A

	Additional Error	N/A
	Range 2	0.0uA ~ 7.8uA, DC
	Resolution	0.1uA
	Additional Error	DC: add $\pm(2\%$ of reading + 0.2% of range) to base accuracy
	Range 3	0.0uA ~ 31.5uA, DC
	Resolution	0.1uA
	Additional Error	DC: add $\pm(2\%$ of reading + 0.2% of range) to base accuracy
	Range 4	0.0uA ~ 126.0uA, DC
	Resolution	0.1uA
	Additional Error	DC: add $\pm(2\%$ of reading + 0.2% of range) to base accuracy
	Range 5	0.0uA ~ 504uA, DC
	Resolution	0.1uA
	Additional Error	DC: add $\pm(2\%$ of reading + 0.2% of range) to base accuracy
	Range 6	0.0uA ~ 999.9uA, 1000uA ~ 1200uA, DC
	Resolution	0.1uA, 1uA
	Additional Error	DC: add $\pm(2\%$ of reading + 0.2% of range) to base accuracy
<b>DISPLAY AUTO RANGE</b>		
Touch Current Display (Peak) (AC+DC)	Range 1	0.0uA ~ 32.0uA, frequency DC, 15Hz – 1MHz
	Resolution	0.1uA
	Accuracy	DC: $\pm(2\%$ of reading + 3counts) , 15Hz $\leq$ f < 1MHz: $\pm(10\%$ of reading + 2uA)
	Range 2	28.0uA ~ 130.0uA, frequency DC, 15Hz - 1MHz
	Resolution	0.1uA

	Accuracy	DC: $\pm(2\% \text{ of reading} + 3\text{counts})$ , $15\text{Hz} \leq f < 1\text{MHz}$ : $\pm(10\% \text{ of reading} + 2\mu\text{A})$
	Range 3	120.0 $\mu\text{A}$ ~ 525.0 $\mu\text{A}$ , frequency DC, 15Hz - 1MHz
	Resolution	0.1 $\mu\text{A}$
	Accuracy	DC: $\pm(2\% \text{ of reading} + 3\text{counts})$ , $15\text{Hz} \leq f < 1\text{MHz}$ : $\pm(10\% \text{ of reading} + 2\mu\text{A})$
	Range 4	400 $\mu\text{A}$ ~ 999.9 $\mu\text{A}$ , 1000 $\mu\text{A}$ -2100 $\mu\text{A}$ , frequency DC, 15Hz - 1MHz
	Resolution	0.1 $\mu\text{A}$ , 1 $\mu\text{A}$
	Accuracy	DC: $\pm(2\% \text{ of reading} + 3\text{counts})$ , $15\text{Hz} \leq f < 1\text{MHz}$ : $\pm(10\% \text{ of reading} + 2\mu\text{A})$
	Range 5	1800 $\mu\text{A}$ ~ 8400 $\mu\text{A}$ , frequency DC, 15Hz - 1MHz
	Resolution	1 $\mu\text{A}$
	Accuracy	DC: $\pm(2\% \text{ of reading} + 3\text{counts})$ , $15\text{Hz} \leq f < 1\text{MHz}$ : $\pm(10\% \text{ of reading} + 2\mu\text{A})$
	Range 6	8000 $\mu\text{A}$ ~ 8399 $\mu\text{A}$ , 8.40mA ~ 30.00mA, frequency DC, 15Hz – 100KHz
	Resolution	1 $\mu\text{A}$ , 0.01mA
	Accuracy	DC: $\pm(2\% \text{ of reading} + 3\text{counts})$ , $15\text{Hz} \leq f < 100\text{KHz}$ : $\pm(10\% \text{ of reading} + 2\text{counts})$
<b>DISPLAY FIXED RANGE (&gt;6% OF RANGE)</b>		
Touch Current Display (Peak) (AC+DC)	Range 1	0.0 $\mu\text{A}$ ~ 32.0 $\mu\text{A}$ , frequency 15Hz - 1MHz
	Resolution	0.1 $\mu\text{A}$
	Base Accuracy	DC: $\pm(2\% \text{ of reading} + 2\mu\text{A})$ $15\text{Hz} \leq f \leq 100\text{KHz}$ : $\pm(10\% \text{ of reading} + 2\mu\text{A})$ $100\text{KHz} \leq f \leq 1\text{MHz}$ : $\pm(10\% \text{ of reading} + 2\mu\text{A})$
	Range 2	7.8 $\mu\text{A}$ ~ 130.0 $\mu\text{A}$ , frequency 15Hz - 1MHz
	Resolution	0.1 $\mu\text{A}$



	Base Accuracy	DC: $\pm(2\%$ of reading + 2 $\mu$ A) 15Hz $\leq$ f $\leq$ 100KHz : $\pm(10\%$ of reading + 2 $\mu$ A) 100KHz $\leq$ f $\leq$ 1MHZ : $\pm(10\%$ of reading + 2 $\mu$ A)
	Range 3	31.5 $\mu$ A ~ 525.0 $\mu$ A, frequency 15Hz - 1MHz
	Resolution	0.1 $\mu$ A
	Base Accuracy	DC: $\pm(2\%$ of reading + 2 $\mu$ A) 15Hz $\leq$ f $\leq$ 100KHz : $\pm(10\%$ of reading + 2 $\mu$ A) 100KHz $\leq$ f $\leq$ 1MHZ : $\pm(10\%$ of reading + 2 $\mu$ A)
	Range 4	126.0 $\mu$ A ~ 999.9 $\mu$ A, 1000 $\mu$ A ~ 2100 $\mu$ A, frequency 15Hz - 1MHz
	Resolution	0.1 $\mu$ A, 1 $\mu$ A
	Base Accuracy	DC: $\pm(2\%$ of reading + 2 $\mu$ A) 15Hz $\leq$ f $\leq$ 100KHz : $\pm(10\%$ of reading + 2 $\mu$ A) 100KHz $\leq$ f $\leq$ 1MHZ : $\pm(10\%$ of reading + 2 $\mu$ A)
	Range 5	504 $\mu$ A ~ 999.9 $\mu$ A, 1000 $\mu$ A ~ 8400 $\mu$ A, frequency 15Hz - 1MHz
	Resolution	0.1 $\mu$ A, 1 $\mu$ A
	Base Accuracy	DC: $\pm(2\%$ of reading + 2 $\mu$ A) 15Hz $\leq$ f $\leq$ 100KHz : $\pm(10\%$ of reading + 2 $\mu$ A) 100KHz $\leq$ f $\leq$ 1MHZ : $\pm(10\%$ of reading + 2 $\mu$ A)
	Range 6	1200 $\mu$ A ~ 8399 $\mu$ A, 8.40mA ~ 30.00mA, frequency 15Hz - 1MHz
	Resolution	1 $\mu$ A, 0.01mA
	Base Accuracy	DC: $\pm(2\%$ of reading + 3counts) ,15Hz $\leq$ f <100KHz: $\pm(10\%$ of reading + 2counts)
<b>DISPLAY FIXED RANGE (&lt;6% OF RANGE)</b>		
Touch Current Display (Peak) (AC+DC)	Range 1	N/A
	Resolution	N/A
	Additional Error	N/A

	Range 2	0.0uA ~ 7.8uA, frequency 15Hz - 1MHz
	Resolution	0.1uA
	Additional Error	DC: add $\pm(2\%$ of reading + 0.2% of range) to base accuracy $15\text{Hz} \leq f \leq 100\text{KHz}$ : add $\pm(2\%$ of reading + 0.2% of range) to base accuracy $100\text{KHz} \leq f \leq 1\text{MHz}$ : add $\pm(2\%$ of reading + 0.5% of range) to base accuracy
	Range 3	0.0uA ~ 31.5uA, frequency 15Hz - 1MHz
	Resolution	0.1uA
	Additional Error	DC: add $\pm(2\%$ of reading + 0.2% of range) to base accuracy $15\text{Hz} \leq f \leq 100\text{KHz}$ : add $\pm(2\%$ of reading + 0.2% of range) to base accuracy $100\text{KHz} \leq f \leq 1\text{MHz}$ : add $\pm(2\%$ of reading + 0.5% of range) to base accuracy
	Range 4	0.0uA ~ 126.0uA, frequency 15Hz - 1MHz
	Resolution	0.1uA
	Additional Error	DC: add $\pm(2\%$ of reading + 0.2% of range) to base accuracy $15\text{Hz} \leq f \leq 100\text{KHz}$ : add $\pm(2\%$ of reading + 0.2% of range) to base accuracy $100\text{KHz} \leq f \leq 1\text{MHz}$ : add $\pm(2\%$ of reading + 0.5% of range) to base accuracy
	Range 5	0.0uA ~ 504uA, frequency 15Hz - 1MHz
	Resolution	0.1uA

	Additional Error	DC: add $\pm(2\%$ of reading + 0.2% of range) to base accuracy $15\text{Hz} \leq f \leq 100\text{KHz}$ : add $\pm(2\%$ of reading + 0.2% of range) to base accuracy $100\text{KHz} \leq f \leq 1\text{MHz}$ : add $\pm(2\%$ of reading + 0.5% of range) to base accuracy
	Range 6	0.0uA ~ 999.9uA, 1000uA ~ 1800uA, frequency DC – 100KHz
	Resolution	0.1uA, 1uA
	Additional Error	DC: add $\pm(2\%$ of reading + 0.2% of range) to base accuracy $15\text{Hz} \leq f \leq 100\text{KHz}$ : add $\pm(2\%$ of reading + 0.2% of range) to base accuracy
<b>DISPLAY AUTO RANGE</b>		
Touch Current Display (Peak) (AC Only)	Range 1	0.0uA ~ 32.0uA, frequency DC, 15Hz – 1MHz
	Resolution	0.1uA
	Accuracy	$15\text{Hz} \leq f < 1\text{MHz}$ : $\pm(10\%$ of reading + 2uA)
	Range 2	28.0uA ~ 130.0uA, frequency DC, 15Hz - 1MHz
	Resolution	0.1uA
	Accuracy	$15\text{Hz} \leq f < 1\text{MHz}$ : $\pm(10\%$ of reading + 2uA)
	Range 3	120.0uA ~ 525.0uA, frequency DC, 15Hz - 1MHz
	Resolution	0.1uA
	Accuracy	$15\text{Hz} \leq f < 1\text{MHz}$ : $\pm(10\%$ of reading + 2uA)
	Range 4	400uA ~ 999.9uA, 1000uA-2100uA, frequency DC, 15Hz - 1MHz
	Resolution	0.1uA, 1uA
	Accuracy	$15\text{Hz} \leq f < 1\text{MHz}$ : $\pm(10\%$ of reading + 2uA)
	Range 5	1800uA ~ 8400uA, frequency DC, 15Hz - 1MHz
	Resolution	1uA

	Accuracy	15Hz ≤ f < 1MHz: ±(10% of reading + 2uA)
	Range 6	8000uA ~ 8399uA, 8.40mA ~ 30.00mA, frequency DC, 15Hz – 100KHz
	Resolution	1uA, 0.01mA
	Accuracy	15Hz ≤ f < 100KHz: ±(10% of reading + 2counts)
<b>DISPLAY FIXED RANGE (&gt;6% OF RANGE)</b>		
Touch Current Display (Peak) (AC Only)	Range 1	0.0uA ~ 32.0uA, frequency 15Hz - 1MHz
	Resolution	0.1uA
	Base Accuracy	15Hz ≤ f ≤ 100KHz : ±(10% of reading + 2uA) 100KHz ≤ f ≤ 1MHz : ±(10% of reading + 2uA)
	Range 2	7.8uA ~ 130.0uA, frequency 15Hz - 1MHz
	Resolution	0.1uA
	Base Accuracy	15Hz ≤ f ≤ 100KHz : ±(10% of reading + 2uA) 100KHz ≤ f ≤ 1MHz : ±(10% of reading + 2uA)
	Range 3	31.5uA ~ 525.0uA, frequency 15Hz - 1MHz
	Resolution	0.1uA
	Base Accuracy	15Hz ≤ f ≤ 100KHz : ±(10% of reading + 2uA) 100KHz ≤ f ≤ 1MHz : ±(10% of reading + 2uA)
	Range 4	126.0uA ~ 999.9uA, 1000uA ~ 2100uA, frequency 15Hz - 1MHz
	Resolution	0.1uA, 1uA
	Base Accuracy	15Hz ≤ f ≤ 100KHz : ±(10% of reading + 2uA) 100KHz ≤ f ≤ 1MHz : ±(10% of reading + 2uA)
	Range 5	504uA ~ 999.9uA, 1000uA ~ 8400uA, frequency 15Hz - 1MHz
	Resolution	0.1uA, 1uA

	Base Accuracy	15Hz ≤ f ≤ 100KHz : ±(10% of reading + 2uA) 100KHz ≤ f ≤ 1MHZ : ±(10% of reading + 2uA)	
	Range 6	1800uA ~ 8399uA, 8.40mA ~ 30.00mA, frequency 15Hz - 1MHz	
	Resolution	1uA, 0.01mA	
	Base Accuracy	15Hz ≤ f < 100KHz: ±(10% of reading + 2counts)	
<b>DISPLAY FIXED RANGE (&lt;6% OF RANGE)</b>			
Touch Current Display (Peak) (AC Only)	Range 1	N/A	
	Resolution	N/A	
	Additional Error	N/A	
	Range 2	0.0uA ~ 7.8uA, frequency 15Hz - 1MHz	
	Resolution	0.1uA	
	Additional Error	15Hz ≤ f ≤ 100KHz : add ±(2% of reading + 0.2% of range) to base accuracy 100KHz ≤ f ≤ 1MHZ : add ±(2% of reading + 0.5% of range) to base accuracy	
	Range 3	0.0uA ~ 31.5uA, frequency 15Hz - 1MHz	
	Resolution	0.1uA	
	Additional Error	15Hz ≤ f ≤ 100KHz : add ±(2% of reading + 0.2% of range) to base accuracy 100KHz ≤ f ≤ 1MHZ : add ±(2% of reading + 0.5% of range) to base accuracy	
	Range 4	0.0uA ~ 126.0uA, frequency 15Hz - 1MHz	
	Resolution	0.1uA	
	Additional Error	15Hz ≤ f ≤ 100KHz : add ±(2% of reading + 0.2% of range) to base accuracy 100KHz ≤ f ≤ 1MHZ : add ±(2% of reading + 0.5% of range) to base accuracy	

	Range 5	0.0uA ~ 504uA, frequency 15Hz - 1MHz
	Resolution	0.1uA
	Additional Error	15Hz $\leq$ f $\leq$ 100KHz : add $\pm$ (2% of reading + 0.2% of range) to base accuracy 100KHz $\leq$ f $\leq$ 1MHZ : add $\pm$ (2% of reading + 0.5% of range) to base accuracy
	Range 6	0.0uA ~ 999.9uA, 1000uA ~ 1800uA, frequency DC – 100KHz
	Resolution	0.1uA, 1uA
	Additional Error	15Hz $\leq$ f $\leq$ 100KHz : add $\pm$ (2% of reading + 0.2% of range) to base accuracy
<b>DISPLAY AUTO RANGE</b>		
Touch Voltage Display (RMS) (AC+DC)	Range 1	0.0mV ~ 32.0mV, frequency DC, 15Hz – 1MHz
	Resolution	0.1uA
	Accuracy	DC , 15Hz $\leq$ f <100KHz: $\pm$ (2% of reading + 3counts) 100KHz $\leq$ f $\leq$ 1MHZ : $\pm$ 5% of reading (10.0mV - 999.9mV)
	Range 2	28.0mV ~ 130.0mV, frequency DC, 15Hz - 1MHz
	Resolution	0.1mV
	Accuracy	DC , 15Hz $\leq$ f <100KHz: $\pm$ (2% of reading + 3counts) 100KHz $\leq$ f $\leq$ 1MHZ : $\pm$ 5% of reading (10.0mV - 999.9mV)
	Range 3	120.0mV ~ 525.0mV, frequency DC, 15Hz - 1MHz
	Resolution	0.1mV
	Accuracy	DC , 15Hz $\leq$ f <100KHz: $\pm$ (2% of reading + 3counts) 100KHz $\leq$ f $\leq$ 1MHZ : $\pm$ 5% of reading (10.0mV - 999.9mV)
	Range 4	400mV ~ 999.9mV, 1000mV ~ 2100mV, frequency DC, 15Hz - 1MHz
	Resolution	0.1mV, 1mV

	Accuracy	DC , 15Hz $\leq$ f <100KHz: $\pm$ (2% of reading + 3counts) 100KHz $\leq$ f $\leq$ 1MHZ : $\pm$ 5% of reading (10mV - 8500mV)
	Range 5	1800mV ~ 8400mV, frequency DC, 15Hz - 1MHz
	Resolution	1mV
	Accuracy	DC , 15Hz $\leq$ f <100KHz: $\pm$ (2% of reading + 3counts) 100KHz $\leq$ f $\leq$ 1MHZ : $\pm$ 5% of reading (10mV - 8500mV)
	Range 6	8000mV ~ 8399mV, 8.40V ~ 20.00V, frequency DC, 15Hz – 100kHz
	Resolution	1mV, 0.01V
	Accuracy	DC, 15Hz < f < 100KHz : $\pm$ 5% of reading (0.01V -20.00V )
<b>DISPLAY FIXED RANGE (&gt;6% OF RANGE)</b>		
Touch Voltage Display (RMS) (AC+DC)	Range 1	0.0mV ~ 32.0mV, frequency DC, 15Hz – 1MHz
	Resolution	0.1mV
	Basic Accuracy	DC , 15Hz $\leq$ f <100KHz: $\pm$ (2% of reading + 3counts) 100KHz $\leq$ f $\leq$ 1MHZ : $\pm$ 5% of reading (10.0mV - 999.9mV)
	Range 2	7.8mV ~ 130.0mV, frequency DC, 15Hz - 1MHz
	Resolution	0.1mV
	Basic Accuracy	DC , 15Hz $\leq$ f <100KHz: $\pm$ (2% of reading + 3counts) 100KHz $\leq$ f $\leq$ 1MHZ : $\pm$ 5% of reading (10.0mV - 999.9mV)
	Range 3	31.5mV ~ 525.0mV, frequency DC, 15Hz - 1MHz
	Resolution	0.1mV
	Basic Accuracy	DC , 15Hz $\leq$ f <100KHz: $\pm$ (2% of reading + 3counts) 100KHz $\leq$ f $\leq$ 1MHZ : $\pm$ 5% of reading (10.0mV - 999.9mV)
	Range 4	126.0mV ~ 999.9mV, 1000mV ~ 2100mV, frequency DC, 15Hz - 1MHz
	Resolution	0.1mV, 1mV
	Basic Accuracy	DC , 15Hz $\leq$ f <100KHz: $\pm$ (2% of reading + 3counts)

		100KHz $\leq$ f $\leq$ 1MHZ : $\pm$ 5% of reading (10mV - 8500mV)
	Range 5	504.0mV ~ 999.9mV, 1000mV ~ 8400mV, frequency DC, 15Hz - 1MHz
	Resolution	0.1mV, 1mV
	Basic Accuracy	DC , 15Hz $\leq$ f < 100KHz: $\pm$ (2% of reading + 3counts) 100KHz $\leq$ f $\leq$ 1MHZ : $\pm$ 5% of reading (10mV - 8500mV)
	Range 6	1200mV ~ 8399mV, 8.40V ~ 20.00V, frequency DC, 15Hz – 100kHz
	Resolution	1mV, 0.01V
	Basic Accuracy	DC, 15Hz < f < 100KHz : $\pm$ 5% of reading (0.01V -20.00V )
<b>DISPLAY FIXED RANGE (&lt;6% OF RANGE)</b>		
Touch Voltage Display (RMS) (AC+DC)	Range 1	N/A
	Resolution	N/A
	Additional Error	N/A
	Range 2	0.0mV ~ 7.8mV, frequency 15Hz - 1MHz
	Resolution	0.1mV
	Additional Error	15Hz $\leq$ f $\leq$ 100KHz : add $\pm$ (2% of reading + 0.2% of range) to base accuracy 100KHz $\leq$ f $\leq$ 1MHZ : add $\pm$ (2% of reading + 0.5% of range) to base accuracy
	Range 3	0.0mV ~ 31.5mV, frequency 15Hz - 1MHz
	Resolution	0.1mV
	Additional Error	15Hz $\leq$ f $\leq$ 100KHz : add $\pm$ (2% of reading + 0.2% of range) to base accuracy 100KHz $\leq$ f $\leq$ 1MHZ : add $\pm$ (2% of reading + 0.5% of range) to base accuracy



	Range 4	0.0mV ~ 126.0mV, frequency 15Hz - 1MHz
	Resolution	0.1mV
	Additional Error	15Hz $\leq$ f $\leq$ 100KHz : add $\pm$ (2% of reading + 0.2% of range) to base accuracy 100KHz $\leq$ f $\leq$ 1MHz : add $\pm$ (2% of reading + 0.5% of range) to base accuracy
	Range 5	0.0mV ~ 504mV, frequency 15Hz - 1MHz
	Resolution	0.1mV
	Additional Error	15Hz $\leq$ f $\leq$ 100KHz : add $\pm$ (2% of reading + 0.2% of range) to base accuracy 100KHz $\leq$ f $\leq$ 1MHz : add $\pm$ (2% of reading + 0.5% of range) to base accuracy
	Range 6	0.0mV ~ 999.9mV, 1000mV ~ 1200mV, frequency DC – 100KHz
	Resolution	0.1mV, 1mV
	Additional Error	DC, 15Hz $\leq$ f $\leq$ 100KHz : add $\pm$ (2% of reading + 0.2% of range) to base accuracy
<b>DISPLAY AUTO RANGE</b>		
Touch Voltage Display (RMS) (AC Only)	Range 1	0.0mV ~ 32.0mV, frequency DC, 15Hz – 1MHz
	Resolution	0.1mV
	Accuracy	15Hz $\leq$ f < 30Hz: $\pm$ (3% of reading + 5counts) 30Hz $\leq$ f < 100KHz: $\pm$ (2% of reading + 3counts) 100KHz $\leq$ f $\leq$ 1MHz : $\pm$ 5% of reading (10.0mV - 999.9mV)
	Range 2	28.0mV ~ 130.0mV, frequency DC, 15Hz - 1MHz
	Resolution	0.1mV
	Accuracy	15Hz $\leq$ f < 30Hz: $\pm$ (3% of reading + 5counts) 30Hz $\leq$ f < 100KHz: $\pm$ (2% of reading + 3counts)

		100KHz $\leq$ f $\leq$ 1MHZ : $\pm$ 5% of reading (10.0mV - 999.9mV)
	Range 3	120.0mV ~ 525.0mV, frequency DC, 15Hz - 1MHz
	Resolution	0.1mV
	Accuracy	15Hz $\leq$ f < 30Hz: $\pm$ (3% of reading + 5counts) 30Hz $\leq$ f < 100KHz: $\pm$ (2% of reading + 3counts) 100KHz $\leq$ f $\leq$ 1MHZ : $\pm$ 5% of reading (10.0mV - 999.9mV)
	Range 4	400mV ~ 999.9mV, 1000mV ~ 2100mV, frequency DC, 15Hz - 1MHz
	Resolution	0.1mV, 1mV
	Accuracy	15Hz $\leq$ f < 30Hz: $\pm$ (3% of reading + 5counts) 30Hz $\leq$ f < 100KHz: $\pm$ (2% of reading + 3counts) 100KHz $\leq$ f $\leq$ 1MHZ : $\pm$ 5% of reading (10.0mV - 999.9mV)
	Range 5	1800mV ~ 8400mV, frequency DC, 15Hz - 1MHz
	Resolution	1mV
	Accuracy	15Hz $\leq$ f < 30Hz: $\pm$ (3% of reading + 5counts) 30Hz $\leq$ f < 100KHz: $\pm$ (2% of reading + 3counts) 100KHz $\leq$ f $\leq$ 1MHZ : $\pm$ 5% of reading (10.0mV - 999.9mV)
	Range 6	8000mV ~ 8399mV, 8.40V ~ 20.00V, frequency DC, 15Hz – 100kHz
	Resolution	1mV, 0.01V
	Accuracy	15Hz < f < 100KHz : $\pm$ 5% of reading (0.01V -20.00V )
<b>DISPLAY FIXED RANGE (&gt;6% OF RANGE)</b>		
Touch Voltage Display (RMS) (AC Only)	Range 1	0.0mV ~ 32.0mV, frequency DC, 15Hz – 1MHz
	Resolution	0.1mV
	Basic Accuracy	15Hz $\leq$ f < 30Hz: $\pm$ (3% of reading + 5counts) 30Hz $\leq$ f < 100KHz: $\pm$ (2% of reading + 3counts)

		$100\text{KHz} \leq f \leq 1\text{MHz}$ : $\pm 5\%$ of reading (10.0mV - 999.9mV)
	Range 2	7.8mV ~ 130.0mV, frequency DC, 15Hz - 1MHz
	Resolution	0.1mV
	Basic Accuracy	$15\text{Hz} \leq f < 30\text{Hz}$ : $\pm(3\%$ of reading + 5counts) $30\text{Hz} \leq f < 100\text{KHz}$ : $\pm(2\%$ of reading + 3counts) $100\text{KHz} \leq f \leq 1\text{MHz}$ : $\pm 5\%$ of reading (10.0mV - 999.9mV)
	Range 3	31.5mV ~ 525.0mV, frequency DC, 15Hz - 1MHz
	Resolution	0.1mV
	Basic Accuracy	$15\text{Hz} \leq f < 30\text{Hz}$ : $\pm(3\%$ of reading + 5counts) $30\text{Hz} \leq f < 100\text{KHz}$ : $\pm(2\%$ of reading + 3counts) $100\text{KHz} \leq f \leq 1\text{MHz}$ : $\pm 5\%$ of reading (10.0mV - 999.9mV)
	Range 4	126.0mV ~ 999.9mV, 1000mV ~ 2100mV, frequency DC, 15Hz - 1MHz
	Resolution	0.1mV, 1mV
	Basic Accuracy	$15\text{Hz} \leq f < 30\text{Hz}$ : $\pm(3\%$ of reading + 5counts) $30\text{Hz} \leq f < 100\text{KHz}$ : $\pm(2\%$ of reading + 3counts) $100\text{KHz} \leq f \leq 1\text{MHz}$ : $\pm 5\%$ of reading (10.0mV - 999.9mV)
	Range 5	504.0mV ~ 999.9mV, 1000mV ~ 8400mV, frequency DC, 15Hz - 1MHz
	Resolution	0.1mV, 1mV
	Basic Accuracy	$15\text{Hz} \leq f < 30\text{Hz}$ : $\pm(3\%$ of reading + 5counts) $30\text{Hz} \leq f < 100\text{KHz}$ : $\pm(2\%$ of reading + 3counts) $100\text{KHz} \leq f \leq 1\text{MHz}$ : $\pm 5\%$ of reading (10.0mV - 999.9mV)
	Range 6	1200mV ~ 8399mV, 8.40V ~ 20.00V, frequency DC, 15Hz – 100kHz
	Resolution	1mV, 0.01V

	Basic Accuracy	15Hz < f < 100KHz : $\pm 5\%$ of reading (0.01V -20.00V )
<b>DISPLAY FIXED RANGE (&lt;6% OF RANGE)</b>		
Touch Voltage Display (RMS) (AC Only)	Range 1	N/A
	Resolution	N/A
	Additional Error	N/A
	Range 2	0.0mV ~ 7.8mV, frequency 15Hz - 1MHz
	Resolution	0.1mV
	Additional Error	15Hz $\leq$ f $\leq$ 30Hz : add $\pm(2\%$ of reading + 0.2% of range) to base accuracy 30Hz $\leq$ f $\leq$ 100KHz: add $\pm(2\%$ of reading + 0.2% of range) to base accuracy 100KHz $\leq$ f $\leq$ 1MHZ : add $\pm(2\%$ of reading + 0.5% of range) to base accuracy
	Range 3	0.0mV ~ 31.5mV, frequency 15Hz - 1MHz
	Resolution	0.1mV
	Additional Error	15Hz $\leq$ f $\leq$ 30Hz : add $\pm(2\%$ of reading + 0.2% of range) to base accuracy 30Hz $\leq$ f $\leq$ 100KHz: add $\pm(2\%$ of reading + 0.2% of range) to base accuracy 100KHz $\leq$ f $\leq$ 1MHZ : add $\pm(2\%$ of reading + 0.5% of range) to base accuracy
	Range 4	0.0mV ~ 126.0mV, frequency 15Hz - 1MHz
	Resolution	0.1mV

	Additional Error	$15\text{Hz} \leq f \leq 30\text{Hz}$ : add $\pm(2\%$ of reading + 0.2% of range) to base accuracy $30\text{Hz} \leq f \leq 100\text{KHz}$ : add $\pm(2\%$ of reading + 0.2% of range) to base accuracy $100\text{KHz} \leq f \leq 1\text{MHz}$ : add $\pm(2\%$ of reading + 0.5% of range) to base accuracy
	Range 5	0.0mV ~ 504mV, frequency 15Hz - 1MHz
	Resolution	0.1mV
	Additional Error	$15\text{Hz} \leq f \leq 30\text{Hz}$ : add $\pm(2\%$ of reading + 0.2% of range) to base accuracy $30\text{Hz} \leq f \leq 100\text{KHz}$ : add $\pm(2\%$ of reading + 0.2% of range) to base accuracy $100\text{KHz} \leq f \leq 1\text{MHz}$ : add $\pm(2\%$ of reading + 0.5% of range) to base accuracy
	Range 6	0.0mV ~ 999.9mV, 1000mV ~ 1200mV, frequency DC – 100KHz
	Resolution	0.1mV, 1mV
	Additional Error	$15\text{Hz} \leq f \leq 100\text{KHz}$ : add $\pm(2\%$ of reading + 0.2% of range) to base accuracy
<b>DISPLAY AUTO RANGE</b>		
Touch Voltage Display (DC Only)	Range 1	0.0mV ~ 32.0mV, DC
	Resolution	0.1mV
	Accuracy	DC : $\pm(2\%$ of reading + 3counts) (>10.0mV)
	Range 2	28.0mV ~ 130.0mV, DC
	Resolution	0.1mV
	Accuracy	DC : $\pm(2\%$ of reading + 3counts) (>10.0mV)
	Range 3	120.0mV ~ 525.0mV, DC
	Resolution	0.1mV
	Accuracy	DC : $\pm(2\%$ of reading + 3counts) (>10.0mV)
	Range 4	400mV ~ 2100mV, DC

	Resolution	1mV
	Accuracy	DC : $\pm(2\%$ of reading + 3counts) ( $>10.0\text{mV}$ )
	Range 5	1800mV ~ 8400mV, DC
	Resolution	1mV
	Accuracy	DC : $\pm(2\%$ of reading + 3counts) ( $>10.0\text{mV}$ )
	Range 6	8.00V ~ 20.00V, DC
	Resolution	0.01V
	Accuracy	DC : $\pm 5\%$ of reading (0.01V - 20.00V )
<b>DISPLAY FIXED RANGE (&gt;6% OF RANGE)</b>		
Touch Voltage Display (DC Only)	Range 1	0.0mV ~ 32.0mV, DC
	Resolution	0.1mV
	Base Accuracy	DC : $\pm(2\%$ of reading + 3counts) ( $>10\text{mV}$ )
	Range 2	7.8mV ~ 130.0mV, DC
	Resolution	0.1mV
	Base Accuracy	DC : $\pm(2\%$ of reading + 3counts) ( $>10\text{mV}$ )
	Range 3	31.5mV ~ 525.0mV, DC
	Resolution	0.1mV
	Base Accuracy	DC : $\pm(2\%$ of reading + 3counts) ( $>10\text{mV}$ )
	Range 4	126.0mV ~ 999.9mV, 1000mV ~ 2100mV, DC
	Resolution	0.1mV, 1mV
	Base Accuracy	DC : $\pm(2\%$ of reading + 3counts) ( $>10\text{mV}$ )
	Range 5	504mV ~ 999.9mV, 1000mV ~ 8400mV, DC
	Resolution	0.1mV, 1mV
	Base Accuracy	DC : $\pm(2\%$ of reading + 3counts) ( $>10\text{mV}$ )

	Range 6	1200mV ~ 8399mV, 8.40mA ~ 20.00mA, DC
	Resolution	1mV, 0.01V
	Base Accuracy	DC : $\pm 5\%$ of reading (0.01V - 20.00V )
<b>DISPLAY FIXED RANGE (&lt;6% OF RANGE)</b>		
Touch Voltage Display (DC Only)	Range 1	N/A
	Resolution	N/A
	Additional Error	N/A
	Range 2	0.0mV ~ 7.8mV, DC
	Resolution	0.1mV
	Additional Error	DC: add $\pm(2\%$ of reading + 0.2% of range) to base accuracy
	Range 3	0.0mV ~ 31.5mV, DC
	Resolution	0.1mV
	Additional Error	DC: add $\pm(2\%$ of reading + 0.2% of range) to base accuracy
	Range 4	0.0mV ~ 126.0mV, DC
	Resolution	0.1mV
	Additional Error	DC: add $\pm(2\%$ of reading + 0.2% of range) to base accuracy
		Range 5
	Resolution	0.1mV
	Additional Error	DC: add $\pm(2\%$ of reading + 0.2% of range) to base accuracy
	Range 6	0.0mV ~ 999.9mV, 1000mV ~ 1200mV, DC
	Resolution	0.1mV, 1mV
	Additional Error	DC: add $\pm(2\%$ of reading + 0.2% of range) to base accuracy
<b>DISPLAY AUTO RANGE</b>		

Touch Voltage Display (Peak) (AC+DC)	Range 1	0.0mV ~ 32.0mV, frequency DC, 15Hz – 1MHz
	Resolution	0.1mV
	Accuracy	DC: $\pm(2\%$ of reading + 3counts) ,15Hz $\leq$ f <1MHz: $\pm(10\%$ of reading + 2mV)
	Range 2	28.0mV ~ 130.0mV, frequency DC, 15Hz - 1MHz
	Resolution	0.1mV
	Accuracy	DC: $\pm(2\%$ of reading + 3counts) ,15Hz $\leq$ f <1MHz: $\pm(10\%$ of reading + 2mV)
	Range 3	120.0mV ~ 525.0mV, frequency DC, 15Hz - 1MHz
	Resolution	0.1mV
	Accuracy	DC: $\pm(2\%$ of reading + 3counts) ,15Hz $\leq$ f <1MHz: $\pm(10\%$ of reading + 2mV)
	Range 4	400mV ~ 999.9mV, 1000mV-2100mV, frequency DC, 15Hz - 1MHz
	Resolution	0.1mV, 1mV
	Accuracy	DC: $\pm(2\%$ of reading + 3counts) ,15Hz $\leq$ f <1MHz: $\pm(10\%$ of reading + 2mV)
	Range 5	1800mV ~ 8400mV, frequency DC, 15Hz - 1MHz
	Resolution	1mV
	Accuracy	DC: $\pm(2\%$ of reading + 3counts) ,15Hz $\leq$ f <1MHz: $\pm(10\%$ of reading + 2mV)
	Range 6	8000mV ~ 8399mV, 8.40V ~ 30.00V, frequency DC, 15Hz – 100KHz
	Resolution	1mV, 0.01V
	Accuracy	DC: $\pm(2\%$ of reading + 3counts) ,15Hz $\leq$ f <100KHz: $\pm(10\%$ of reading + 2counts)
<b>DISPLAY FIXED RANGE (&gt;6% OF RANGE)</b>		
Touch Voltage Display (Peak) (AC+DC)	Range 1	0.0mV ~ 32.0mV, frequency 15Hz - 1MHz



	Resolution	0.1mV
	Base Accuracy	DC: $\pm(2\%$ of reading + 2 $\mu$ A) $15\text{Hz} \leq f \leq 100\text{KHz}$ : $\pm(10\%$ of reading + 2mV) $100\text{KHz} \leq f \leq 1\text{MHz}$ : $\pm(10\%$ of reading + 2mV)
	Range 2	7.8mV ~ 130.0mV, frequency 15Hz - 1MHz
	Resolution	0.1mV
	Base Accuracy	DC: $\pm(2\%$ of reading + 2 $\mu$ A) $15\text{Hz} \leq f \leq 100\text{KHz}$ : $\pm(10\%$ of reading + 2mV) $100\text{KHz} \leq f \leq 1\text{MHz}$ : $\pm(10\%$ of reading + 2mV)
	Range 3	31.5mV ~ 525.0mV, frequency 15Hz - 1MHz
	Resolution	0.1mV
	Base Accuracy	DC: $\pm(2\%$ of reading + 2 $\mu$ A) $15\text{Hz} \leq f \leq 100\text{KHz}$ : $\pm(10\%$ of reading + 2mV) $100\text{KHz} \leq f \leq 1\text{MHz}$ : $\pm(10\%$ of reading + 2mV)
	Range 4	126.0mV ~ 999.9mV, 1000mV ~ 2100mV, frequency 15Hz - 1MHz
	Resolution	0.1mV, 1mV
	Base Accuracy	DC: $\pm(2\%$ of reading + 2 $\mu$ A) $15\text{Hz} \leq f \leq 100\text{KHz}$ : $\pm(10\%$ of reading + 2mV) $100\text{KHz} \leq f \leq 1\text{MHz}$ : $\pm(10\%$ of reading + 2mV)
	Range 5	504mV ~ 999.9mV, 1000mV ~ 8400mV, frequency 15Hz - 1MHz
	Resolution	0.1mV, 1mV
	Base Accuracy	DC: $\pm(2\%$ of reading + 2 $\mu$ A) $15\text{Hz} \leq f \leq 100\text{KHz}$ : $\pm(10\%$ of reading + 2mV) $100\text{KHz} \leq f \leq 1\text{MHz}$ : $\pm(10\%$ of reading + 2mV)
	Range 6	1800mV ~ 8399mV, 8.40V ~ 30.00V, frequency 15Hz - 1MHz
	Resolution	1mV, 0.01V

	Base Accuracy	DC: $\pm(2\%$ of reading + 3counts) , $15\text{Hz} \leq f < 100\text{KHz}$ : $\pm(10\%$ of reading + 2counts)
<b>DISPLAY FIXED RANGE (&lt;6% OF RANGE)</b>		
Touch Voltage Display (Peak) (AC+DC)	Range 1	N/A
	Resolution	N/A
	Additional Error	N/A
	Range 2	0.0mV ~ 7.8mV, frequency 15Hz - 1MHz
	Resolution	0.1mV
	Additional Error	DC: add $\pm(2\%$ of reading + 0.2% of range) to base accuracy $15\text{Hz} \leq f \leq 100\text{KHz}$ : add $\pm(2\%$ of reading + 0.2% of range) to base accuracy $100\text{KHz} \leq f \leq 1\text{MHz}$ : add $\pm(2\%$ of reading + 0.5% of range) to base accuracy
	Range 3	0.0mV ~ 31.5mV, frequency 15Hz - 1MHz
	Resolution	0.1mV
	Additional Error	DC: add $\pm(2\%$ of reading + 0.2% of range) to base accuracy $15\text{Hz} \leq f \leq 100\text{KHz}$ : add $\pm(2\%$ of reading + 0.2% of range) to base accuracy $100\text{KHz} \leq f \leq 1\text{MHz}$ : add $\pm(2\%$ of reading + 0.5% of range) to base accuracy
	Range 4	0.0mV ~ 126.0mV, frequency 15Hz - 1MHz
	Resolution	0.1mV
	Additional Error	DC: add $\pm(2\%$ of reading + 0.2% of range) to base accuracy $15\text{Hz} \leq f \leq 100\text{KHz}$ : add $\pm(2\%$ of reading + 0.2% of range) to base accuracy $100\text{KHz} \leq f \leq 1\text{MHz}$ : add $\pm(2\%$ of reading + 0.5% of range) to base accuracy

	Range 5	0.0mV ~ 504mV, frequency 15Hz - 1MHz
	Resolution	0.1mV
	Additional Error	DC: add $\pm(2\%$ of reading + 0.2% of range) to base accuracy $15\text{Hz} \leq f \leq 100\text{KHz}$ : add $\pm(2\%$ of reading + 0.2% of range) to base accuracy $100\text{KHz} \leq f \leq 1\text{MHz}$ : add $\pm(2\%$ of reading + 0.5% of range) to base accuracy
	Range 6	0.0mV ~ 999.9mV, 1000mV ~ 1800mV, frequency DC – 100KHz
	Resolution	0.1mV, 1mV
	Additional Error	DC: add $\pm(2\%$ of reading + 0.2% of range) to base accuracy $15\text{Hz} \leq f \leq 100\text{KHz}$ : add $\pm(2\%$ of reading + 0.2% of range) to base accuracy
<b>DISPLAY AUTO RANGE</b>		
Touch Voltage Display (Peak) (AC Only)	Range 1	0.0mV ~ 32.0mV, frequency DC, 15Hz – 1MHz
	Resolution	0.1mV
	Accuracy	$15\text{Hz} \leq f < 1\text{MHz}$ : $\pm(10\%$ of reading + 2mV)
	Range 2	28.0mV ~ 130.0mV, frequency DC, 15Hz - 1MHz
	Resolution	0.1mV
	Accuracy	$15\text{Hz} \leq f < 1\text{MHz}$ : $\pm(10\%$ of reading + 2mV)
	Range 3	120.0mV ~ 525.0mV, frequency DC, 15Hz - 1MHz
	Resolution	0.1mV
	Accuracy	$15\text{Hz} \leq f < 1\text{MHz}$ : $\pm(10\%$ of reading + 2mV)
	Range 4	400mV ~ 999.9mV, 1000mV- 2100mV, frequency DC, 15Hz - 1MHz
	Resolution	0.1mV, 1mV
	Accuracy	$15\text{Hz} \leq f < 1\text{MHz}$ : $\pm(10\%$ of reading + 2mV)

	Range 5	1800mV ~ 8400mV, frequency DC, 15Hz - 1MHz
	Resolution	1mV
	Accuracy	$15\text{Hz} \leq f < 1\text{MHz}$ : $\pm(10\%$ of reading + 2mV)
	Range 6	8000mV ~ 8399mV, 8.40V ~ 30.00V, frequency DC, 15Hz – 100KHz
	Resolution	1mV, 0.01V
	Accuracy	$15\text{Hz} \leq f < 100\text{KHz}$ : $\pm(10\%$ of reading + 2counts)
<b>DISPLAY FIXED RANGE (&gt;6% OF RANGE)</b>		
Touch Voltage Display (Peak) (AC Only)	Range 1	0.0mV ~ 32.0mV, frequency 15Hz - 1MHz
	Resolution	0.1mV
	Base Accuracy	$15\text{Hz} \leq f \leq 100\text{KHz}$ : $\pm(10\%$ of reading + 2mV) $100\text{KHz} \leq f \leq 1\text{MHz}$ : $\pm(10\%$ of reading + 2mV)
	Range 2	7.8mV ~ 130.0mV, frequency 15Hz - 1MHz
	Resolution	0.1mV
	Base Accuracy	$15\text{Hz} \leq f \leq 100\text{KHz}$ : $\pm(10\%$ of reading + 2mV) $100\text{KHz} \leq f \leq 1\text{MHz}$ : $\pm(10\%$ of reading + 2mV)
	Range 3	31.5mV ~ 525.0mV, frequency 15Hz - 1MHz
	Resolution	0.1mV
	Base Accuracy	$15\text{Hz} \leq f \leq 100\text{KHz}$ : $\pm(10\%$ of reading + 2mV) $100\text{KHz} \leq f \leq 1\text{MHz}$ : $\pm(10\%$ of reading + 2mV)
	Range 4	126.0mV ~ 999.9mV, 1000mV ~ 2100mV, frequency 15Hz - 1MHz
	Resolution	0.1mV, 1mV
	Base Accuracy	$15\text{Hz} \leq f \leq 100\text{KHz}$ : $\pm(10\%$ of reading + 2mV) $100\text{KHz} \leq f \leq 1\text{MHz}$ : $\pm(10\%$ of reading + 2mV)

	Range 5	504mV ~ 999.9mV, 1000mV ~ 8400mV, frequency 15Hz - 1MHz
	Resolution	0.1mV, 1mV
	Base Accuracy	15Hz $\leq$ f $\leq$ 100KHz : $\pm$ (10% of reading + 2mV) 100KHz $\leq$ f $\leq$ 1MHz : $\pm$ (10% of reading + 2mV)
	Range 6	1800mV ~ 8399mV, 8.40V ~ 30.00V, frequency 15Hz - 1MHz
	Resolution	1mV, 0.01V
	Base Accuracy	15Hz $\leq$ f < 100KHz: $\pm$ (10% of reading + 2counts)
<b>DISPLAY FIXED RANGE (&lt;6% OF RANGE)</b>		
Touch Voltage Display (Peak) (AC Only)	Range 1	N/A
	Resolution	N/A
	Additional Error	N/A
	Range 2	0.0mV ~ 7.8mV, frequency 15Hz - 1MHz
	Resolution	0.1mV
	Additional Error	15Hz $\leq$ f $\leq$ 100KHz : add $\pm$ (2% of reading + 0.2% of range) to base accuracy 100KHz $\leq$ f $\leq$ 1MHz : add $\pm$ (2% of reading + 0.5% of range) to base accuracy
	Range 3	0.0mV ~ 31.5mV, frequency 15Hz - 1MHz
	Resolution	0.1mV
		Additional Error
	Range 4	0.0mV ~ 126.0mV, frequency 15Hz - 1MHz
	Resolution	0.1mV

	Additional Error	15Hz ≤ f ≤ 100KHz : add ±(2% of reading + 0.2% of range) to base accuracy 100KHz ≤ f ≤ 1MHZ : add ±(2% of reading + 0.5% of range) to base accuracy
	Range 5	0.0mV ~ 504mV, frequency 15Hz - 1MHz
	Resolution	0.1mV
	Additional Error	15Hz ≤ f ≤ 100KHz : add ±(2% of reading + 0.2% of range) to base accuracy 100KHz ≤ f ≤ 1MHZ : add ±(2% of reading + 0.5% of range) to base accuracy
	Range 6	0.0mV ~ 999.9mV, 1000mV ~ 1800mV, frequency DC – 100KHz
	Resolution	0.1mV, 1mV
	Additional Error	15Hz ≤ f ≤ 100KHz : add ±(2% of reading + 0.2% of range) to base accuracy

## 12. INDEX

ADAPTER BOX .....	10, 11, 25, 57, 59, 99, 176
ARC .....	3
BREAKDOWN .....	3, 4
CALIBRATION.....	11, 23, 28, 30, 31, 32, 142, 143, 144, 145, 146, 147, 148, 149, 150, 151, 152, 153, 154, 155, 156, 157, 158, 159, 160, 161, 162, 163, 164, 165, 166, 167, 168, 169, 170, 171, 172, 173, 174, 175
CALIBRATION ALERT .....	8, 28, 30, 32
Alert Date .....	30, 31, 32, 85
Cal Alert .....	85
Cal Date .....	85
Cal Due .....	85
Date.....	28, 29, 30, 31, 32, 85, 86
Time .....	28, 29, 30, 31, 45, 47, 50, 65, 82, 86, 97, 137
CALIBRATION PROCEDURE .....	142
CONNECTED STEPS .	19, 40, 43, 48, 49, 50, 61, 62, 64, 71, 78, 81, 82, 87, 117, 124, 143
CONTRAST .....	19, 33, 39, 85
CONTROLS.....	12, 15, 21, 23, 28, 39, 42, 60, 90, 98, 120
CONTROLS.....	15
DEFAULT PARAMETERS.....	44, 46, 47, 81
DELAY .....	18, 20, 45, 47, 50, 66, 72, 82, 84, 97, 129, 137
DIELECTRIC WITHSTAND TEST .....	81, 118, 125, 126, 128, 129
DISCHARGE .....	7
DUT ....	4, 7, 8, 9, 18, 19, 23, 24, 25, 44, 46, 52, 53, 57, 58, 59, 64, 66, 67, 97, 98, 99, 144, 145, 146, 147, 148, 149, 150, 176, 177, 178
DWELL .....	18, 20, 45, 47, 50, 65, 66, 82, 84, 97, 129
EDIT PARAMETERS.....	29, 30, 32, 39, 40, 44, 46, 48, 62, 84, 85, 105
ESD .....	6, 7
ETHERNET CARD ...	105, 106, 107, 108, 109, 110, 111, 116, 118, 119, 120, 177
EXIT KEY.....	36, 49
FAIL STOP .....	37, 39, 43, 60, 62, 79, 83
FEATURES.....	8, 120, 125
FILE	
Create .....	42, 48
Recall .....	35, 37, 39
Setup.....	42, 43, 48, 49
FILE RECALL .....	35
FREQUENCY .....	3, 4, 15, 16, 17, 54, 56, 84, 180, 181, 182, 183, 184, 185, 186, 187, 188, 189, 190, 191, 192, 193, 194, 195, 196, 197, 198, 199, 200, 201, 202, 204, 205, 206, 207, 208, 209, 210, 211
FRONT PANEL CONTROLS .....	21
GLOSSARY .....	3
GPIB .....	33, 39, 74, 76, 77, 78, 86, 91, 93, 95, 106, 177, 178

INDEX.....	212
INSULATION RESISTANCE .....	25
INTERLOCK .....	8, 19, 24, 60, 68, 72, 73, 86, 87, 176
LCD.....	8, 19, 21, 33, 79, 87, 105, 176
LEAKAGE ....	1, 4, 9, 13, 23, 24, 25, 40, 44, 45, 46, 47, 48, 50, 53, 54, 55, 56, 57, 58, 59, 65, 67, 82, 84, 97, 98, 100, 101, 105, 137, 149
Applied Part.....	25, 53
Earth.....	53, 97, 98
Leakage-HI.....	44, 47, 50, 82, 84, 97, 98, 137
Leakage-LO.....	44, 47, 50, 82, 84, 97, 137
Line .....	25, 50, 54, 56
LOCKOUT .....	19, 60, 68, 72
MEASURING DEVICE .....	23, 24, 25, 44, 50, 53, 55, 56, 170, 171, 172, 173, 176, 178
MEDICAL RESTRICTIONS .....	7
MEMORY. 19, 46, 64, 68, 71, 72, 77, 78, 79, 80, 86, 88, 89, 90, 93, 96, 102, 103, 105, 120, 121, 122, 127, 128, 129, 130, 131, 132	
MENU ...	8, 9, 28, 29, 38, 39, 48, 49, 50, 60, 86, 98, 102, 108, 110, 111, 120, 121, 126, 127, 130, 132
OPERATOR.....	2, 6, 7, 8, 9, 12, 14, 22, 23, 53, 57, 58, 71, 98, 102, 106
OPTIONS.....	23, 25, 32, 40, 46, 74, 78, 96, 108, 109, 121
PARAMETERS	
Test Parameters.....	39, 40, 44, 46, 74, 77
PLC.....	8, 33, 34, 39, 71, 86, 103, 104
POWER .....	1, 4, 6, 12
POWER FACTOR.....	4, 44, 45, 67, 129
PRINTING.....	141
PROBE-HI .....	24, 25, 53, 54, 56, 82, 85, 137, 150, 151, 152, 153, 154, 155, 156, 157, 158, 159, 160, 161, 162, 163, 164, 165, 166, 167, 168, 169, 170, 171, 172, 173, 174, 175
PROBE-LO ..	25, 53, 54, 56, 82, 85, 137, 150, 151, 152, 153, 154, 155, 156, 157, 158, 159, 160, 161, 162, 163, 164, 165, 166, 167, 168, 169, 170, 171, 172, 173, 174, 175
PROGRAMMING .....	28, 39
REAR PANEL CONTROLS .....	12, 23, 98
RECEPTACLE .....	25, 27, 67, 70
REMOTE .	8, 19, 23, 24, 33, 34, 39, 46, 60, 68, 70, 71, 72, 73, 74, 77, 86, 87, 96, 98, 102, 103, 104, 106
REMOTE INTERLOCK .....	60, 68, 72, 73, 86
RESISTANCE .....	4, 7, 12, 25, 55
RETURN.....	13
RS-232.....	26, 74, 77, 88, 91, 93, 105, 106, 118, 178
RUN TEST .....	47, 96, 97, 102, 103, 144, 145, 146
SAFETY .....	1, 2, 3, 5, 7, 12, 25
SAFETY SYMBOLS.....	3
SCANNER .....	85, 106, 118, 120



---

Internal .....	96
Parameter .....	44
Schematic .....	178
Setup .....	100
SECURITY .....	8, 19, 28, 35, 36, 37, 39, 43, 62
SEQUENCE .....	40, 43, 48, 49, 50, 61, 62, 64, 71, 78, 82, 87, 143
SERVICE .....	1, 3, 5, 11, 77, 89, 90, 91, 142
SERVICE INTERVAL .....	5
SETUP .....	8, 12, 21, 28, 29, 30, 33, 35, 37, 39, 40, 41, 42, 43, 48, 49, 50, 62, 64, 78, 82, 83, 86, 96
DUT-HV .....	145, 146, 149
File .....	78, 82, 83, 86
Scanner .....	100
Setup System .....	111, 121
System .....	28
Test .....	39, 40, 42, 48, 49, 50, 96
SETUP TESTS .....	21
SHORT .....	40, 43, 56, 67, 150
SINGLE STEP .....	37, 60, 61, 62, 86
SPECIFICATIONS .....	15
SYSTEM PARAMETERS .....	29, 39, 85
TEST PARAMETERS .....	39, 40, 44, 46, 48, 51, 74, 77, 97
TEST STATION .....	6, 7
UL .....	169, 170
UNPACKING .....	10
VERIFICATION .....	54, 56, 86, 142
WARRANTY .....	1, 2, 5, 142
WARRANTY POLICIES .....	1